

# KENWOOD

AUDIO VIDEO SURROUND RECEIVER

VR-6050

KRF-V7060D

KRF-V6060D

---

## INSTRUCTION MANUAL

KENWOOD CORPORATION

**This instruction manual is for some models. Model availability and features (functions) may differ depending on the country and sales area.**

### ***About the supplied remote control***

Compared to standard remote controls, the remote control supplied with this receiver has several operation modes. These modes enable the remote control to control other audio/video components. In order to effectively use the remote control it is important to read the operating instructions and obtain a proper understanding of the remote control and how to switch its operation modes (etc.). Using the remote control without completely understanding its design and how to switch the operation modes may result in incorrect operations.

# Before applying the power

**⚠ Caution : Read this page carefully to ensure safe operation.**

Units are designed for operation as follows.

**U.S.A. and Canada** ..... **AC 120 V only**  
**Australia** ..... **AC 240 V only**  
**Europe and U.K.** ..... **AC 230 V only**  
**China and Russia** ..... **AC 220 V only**  
**Other countries** ..... **AC 110-120 / 220-240 V switchable\***

## For the United Kingdom

### Factory fitted moulded mains plug

1. The mains plug contains a fuse. For replacement, use only a 13-Amp ASTA-approved (BS1362) fuse.
2. The fuse cover must be refitted when replacing the fuse in the moulded plug.
3. Do not cut off the mains plug from this equipment. If the plug fitted is not suitable for the power points in your home or the cable is too short to reach a power point, then obtain an appropriate safety approved extension lead or adapter, or consult your dealer. If nonetheless the mains plug is cut off, remove the fuse and dispose of the plug immediately, to avoid a possible shock hazard by inadvertent connection to the mains supply.

**IMPORTANT:** The wires in the mains lead are coloured in accordance with the following code:

Blue : Neutral  
Brown : Live

Do not connect those leads to the earth terminal of a three-pin plug.

### \* AC voltage selection

The AC voltage selector switch on the rear panel is set to the voltage that prevails in the area to which the unit is shipped. Before connecting the power cord to your AC outlet, make sure that the setting position of this switch matches your line voltage. If not, it must be set to your voltage in accordance with the following direction.

#### AC voltage selector switch

Move switch lever to match your line voltage with a small screwdriver or other pointed tool.

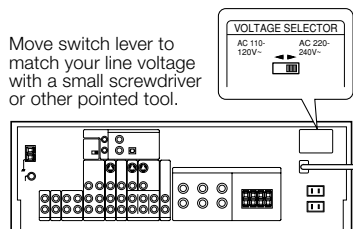

#### Note:

Our warranty does not cover damage caused by excessive line voltage due to improper setting of the AC voltage selector switch.

## Safety precautions

### WARNING :

TO PREVENT FIRE OR ELECTRIC SHOCK,  
DO NOT EXPOSE THIS APPLIANCE TO  
RAIN OR MOISTURE.



**CAUTION**  
RISK OF ELECTRIC SHOCK  
DO NOT OPEN



CAUTION: TO REDUCE THE RISK OF ELECTRIC SHOCK, DO NOT REMOVE COVER (OR BACK). NO USER-SERVICEABLE PARTS INSIDE. REFER SERVICING TO QUALIFIED SERVICE PERSONNEL.





THE LIGHTNING FLASH WITH ARROWHEAD SYMBOL, WITHIN AN EQUILATERAL TRIANGLE, IS INTENDED TO ALERT THE USER TO THE PRESENCE OF UNINSULATED "DANGEROUS VOLTAGE" WITHIN THE PRODUCT'S ENCLOSURE THAT MAY BE OF SUFFICIENT MAGNITUDE TO CONSTITUTE A RISK OF ELECTRIC SHOCK TO PERSONS.



THE EXCLAMATION POINT WITHIN AN EQUILATERAL TRIANGLE IS INTENDED TO ALERT THE USER TO THE PRESENCE OF IMPORTANT OPERATING AND MAINTENANCE (SERVICING) INSTRUCTIONS IN THE LITERATURE ACCOMPANYING THE APPLIANCE.

## Contents

Caution : Read the pages marked  carefully to ensure safe operation.



<b>Preparations</b>	 <b>Before applying the power</b> ..... 2
	 Safety precautions ..... 2
	Unpacking ..... 3
	How to use this manual ..... 4
	Special features ..... 5
	<b>Names and functions of parts</b> ..... 6
	Main Unit ..... 6
	Remote control unit (RC-R0725) (KRF-V7060D) and (RC-R0727) (VR-6050/KRF-V6060D) ..... 7
	Remote control unit (RC-R0726) (KRF-V6060D) (For the U.K. only) ..... 8
	<b>Setting up the system</b> ..... 9
	Connecting audio components ..... 10
	Connecting video components ..... 11
	Digital connections ..... 12
	Connecting a DVD player (6-channel input) ..... 13
	Connecting the speakers ..... 14
Connecting the terminals ..... 15	
Connecting to the AV AUX jacks ..... 16	
Connecting the antennas ..... 16	
Connecting the system control ..... 17	
Preparing the remote control ..... 17	
<b>Preparing for surround sound</b> ..... 18	
Speaker settings ..... 18	
<b>Operations</b>	<b>Normal playback</b> ..... 21
	Preparing for playback ..... 21
	Listening to a source component ..... 21
	Adjusting the sound ..... 22
	<b>Recording</b> ..... 23
	Recording audio (analog sources) ..... 23
	Recording video ..... 23
	Recording audio (digital sources) ..... 23
	<b>Listening to radio broadcasts</b> ..... 24
	Tuning (non-RDS) radio stations ..... 24
	Using RDS (Radio Data System) (For the U.K. only) ..... 24
	Presetting radio stations manually ..... 24
	Receiving preset stations ..... 25
	Receiving preset stations in order (P.CALL) ... 25
	Using the RDS DISP (Display) key (For the U.K. only) ..... 25
Presetting RDS stations (RDS AUTO MEMORY) (For the U.K. only) ..... 26	
Tuning by Program Type (PTY search) (For the U.K. only) ..... 26	
<b>Ambience effects</b> ..... 27	
Surround modes ..... 27	
Surround play ..... 29	
DVD 6-channel playback ..... 30	
Convenient functions ..... 30	
<b>Remote Control</b>	<b>Basic remote control operations for other components</b> ..... 33
	Registering setup codes for other components ..... 33
	Operating other components ..... 34
	Setup code chart (RC-R0727) (VR-6050/KRF-V6060D) (RC-R0725) (KRF-V7060D) ..... 35
	Setup code chart (RC-R0726) (KRF-V6060D) (For the U.K. only) ..... 36
	CASSETTE deck, CD player & MD recorder operations ..... 37
	Other components' operations ..... 38

**Additional Information**

**In case of difficulty** ..... 40  
**Specifications** ..... 42

## Unpacking

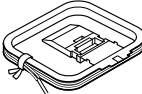
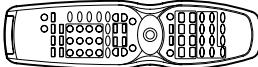
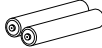
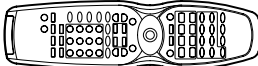
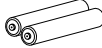
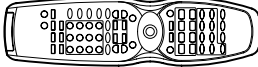
Unpack the unit carefully and make sure that all accessories are present.

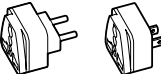
FM indoor antenna (1)	AM loop antenna (1)
	
-----	
<b>For VR-6050/KRF-V6060D</b>	
Remote control unit (1) RC-R0727	Batteries (R6/AA) (2)
	
-----	
<b>For KRF-V6060D (For the U.K. only)</b>	
Remote control unit (1) RC-R0726	Batteries (R6/AA) (2)
	
-----	
<b>For KRF-V7060D</b>	
Remote control unit (1) RC-R0725	Batteries (R6/AA) (2)
	
-----	
*AC plug adaptor (2)	
	*Use to adapt the plug on the power cord to the shape of the wall outlet. (Accessory only for regions where use is necessary.)

If any accessories are missing, or if the unit is damaged or fails to operate, notify your dealer immediately. If the unit was shipped to you directly, notify your shipper immediately. Kenwood recommends that you retain the original carton and packing materials in case you need to move or ship the unit in the future.

**Keep this manual handy for future reference.**

## **How to use this manual**

This manual is divided into four sections, Preparations, Operations, Remote Control, and Additional Information.

### **Preparations**

Shows you how to connect your audio and video components to the receiver and prepare the surround processor.

Since this receiver works with all your audio and video components, we will guide you in setting up your system to be as easy as possible.

### **Operations**

Shows you how to operate the various functions available on the receiver.

### **Remote Control**

Shows you how to operate other components using the remote control, as well as a detailed explanation of all remote control operations. Once you have registered your components with the proper setup codes, you'll be able to operate both this receiver and your other AV components (TV, VCR, DVD player, CD player, etc.) using the remote control supplied with this receiver.

### **Additional Information**

Shows you additional information such as "In case of difficulty" (troubleshooting) and "Specifications".

### **Maintenance of the unit**

When the front panel or case becomes dirty, wipe with a soft, dry cloth. Do not use thinner, benzine, alcohol, etc. for these agents may cause discoloration.

### **In regard to contact cleaner**

Do not use contact cleaners because it could cause a malfunction. Be specially careful not to use contact cleaners containing oil, for they may deform the plastic component.

### **Memory back up function**

Please note that the following items will be deleted from the unit's memory if the power cord is disconnected from the AC outlet for approximately 1 day.

- Power mode.
- Input selector settings.
- Picture output.
- Speaker ON/OFF.
- Volume level.
- BASS, TREBLE, INPUT level.
- TONE ON/OFF.
- LOUDNESS ON/OFF.
- Dimmer level.
- MD/TAPE settings.
- Listen mode setting.
- Speaker settings.
- SW RE-MIX ON/OFF.
- Distance setting.
- Input mode setting.
- Midnight mode setting.
- PRO LOGIC II mode setting.
- CS II mode setting.
- Broadcast band.
- Frequency setting.
- Preset stations.
- Tuning mode.
- DSP mode.
- ACTIVE EQ mode.
- SPEAKER EQ mode.

### **For the U.S.A.**

#### **FCC WARNING**

This equipment may generate or use radio frequency energy. Changes or modifications to this equipment may cause harmful interference unless the modifications are expressly approved in the instruction manual. The user could lose the authority to operate this equipment if an unauthorized change or modification is made.

#### **NOTE:**

This equipment has been tested and found to comply with the limits for a Class B digital device, pursuant to Part 15 of the FCC Rules. These limits are designed to provide reasonable protection against harmful interference in a residential installation. This equipment may cause harmful interference to radio communications, if it is not installed and used in accordance with the instructions. However, there is no guarantee that interference will not occur in a particular installation. If this equipment does cause harmful interference to radio or television reception, which can be determined by turning the equipment off and on, the user is encouraged to try to correct the interference by one or more of the following measures:

- Reorient or relocate the receiving antenna.
- Increase the separation between the equipment and receiver.
- Connect the equipment into an outlet on a circuit different from that to which the receiver is connected.
- Consult the dealer or an experienced radio/TV technician for help.

### **For the U.S.A.**

#### **Note to CATV system installer**

This reminder is provided to call the CATV system installer's attention to Article 820-40 of the NEC that provides guidelines for proper grounding and, in particular, specifies that the cable ground shall be connected to the grounding system of the building, as close to the point of cable entry as practical.



As an ENERGY STAR® Partner, Kenwood Corporation has determined that this product meets the ENERGY STAR® guidelines for energy efficiency.

This product can save energy. Saving energy reduces air pollution and lowers utility bills.

## **Special features**

---

### **True home theater sound**

This receiver incorporates a wide variety of surround modes to bring you maximum enjoyment from your video software. Select a surround mode according to your equipment or the software you are going to play and enjoy! → [27]

### **Dolby Digital and Dolby Digital EX**

The DOLBY DIGITAL mode lets you enjoy full digital surround from software processed in the Dolby Digital format. Dolby Digital provides up to 5.1 channels of independent digital audio for better sound quality and more powerful presence than conventional Dolby Surround.

As for Dolby Digital EX, it creates six full-bandwidth output channels from the 5.1 channel sources. This is done using a matrix decoder that derives three surround channels from the two in the original recording. For best results, Dolby Digital EX should be used with movie soundtracks recorded with Dolby Digital Surround EX.

### **Dolby PRO LOGIC II**

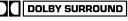
Dolby PRO LOGIC II, whilst totally compatible with its predecessor PRO LOGIC, provides greater advantages in surround sound. It allows the user to enjoy the conventional stereo or Dolby Surround with a convincing "5.1 like" presentation. PRO LOGIC II offers special features for controlling the overall spatial, dimensionality and frontal sound field imaging. PRO LOGIC II produces an impressive surround sound from video software marked  and three-dimensional space from music CD. When listening to music, you will be able to enjoy the experience of sheer STEREO surround sound.

### **DTS**

DTS (Digital Theater System) is a 5.1 channel digital audio format that provides five full-spectrum channels and one low-frequency (subwoofer) channel for unprecedented clarity, optimum channel separation and a (wide) dynamic range.

In the DTS mode, the 5.1 channel digital input from a DTS CD, LD or DVD disc (carrying the "DTS" marking) can be played in Digital Surround.

Important:

When a DTS disc is played on a CD, LD or DVD player, noise may be output from the analog output. It is recommended that you connect the digital output of the player to the digital input of this unit.

### **Multi channel surround sound (SRS Circle Surround II (●)CS)**

SRS Circle Surround II™ improves on its predecessor CS-5.1™ resulting in the CS-6.1™ system, enabling you to listen to realistic, multi-channel, surround sound playback from a stereo source or conventional surround-encoded video source. You already enjoy listening to Dolby digital sound/DTS multi-channel sound with your multi-speakers. Now you can listen to audio CDs, MDs, Broadcast and Home Theater using your multi-speakers. You will discover a new type of sound through SRS Circle Surround II.

### **DSP surround modes**

The DSP (Digital Signal Processor) used for this receiver incorporates a variety of high quality adjustable sound fields, like "ARENA", "JAZZ CLUB", "THEATER", "STADIUM" and "DISCO". It is compatible with almost any kind of program source.

### **DVD 6-channel input**

If you own a DVD player equipped with 6-channel output, this receiver allows you to obtain the full surround sound impact of DVD source material featuring multi-channel encoding. Since the source signals are digital and each channel is input independently, the resulting ambience is far superior to what can be achieved with conventional surround sound systems.

### **ACTIVE EQ**

ACTIVE EQ mode will produce a more dynamic sound quality in any condition. You can enjoy a more impressive sound effect when ACTIVE EQ is turned on during Dolby Digital and DTS playback.

### **SPEAKER EQ**

The SPEAKER EQ function will automatically detect the various features of each speaker and effectively creates a stereoscopic sound effect.

### **Universal IR (InfraRed) remote control**

In addition to the basic receiver, the remote control supplied with this receiver can also operate almost all of your remote controllable audio and video components. Just follow the simple setup procedure to register the components you have connected.

### **RDS (Radio Data System) tuner (For the U.K. only)**

The receiver is equipped with an RDS tuner that provides several convenient tuning functions: RDS Auto Memory, to automatically preset up to 40 RDS stations broadcasting different programs; station name display, to show you the name of the current broadcast station; and PTY search to let you tune stations by program type.

### **PTY (Program Type) search (For the U.K. only)**

Tune the stations by specifying the type of program you want to hear.

# Names and functions of parts

## Main unit

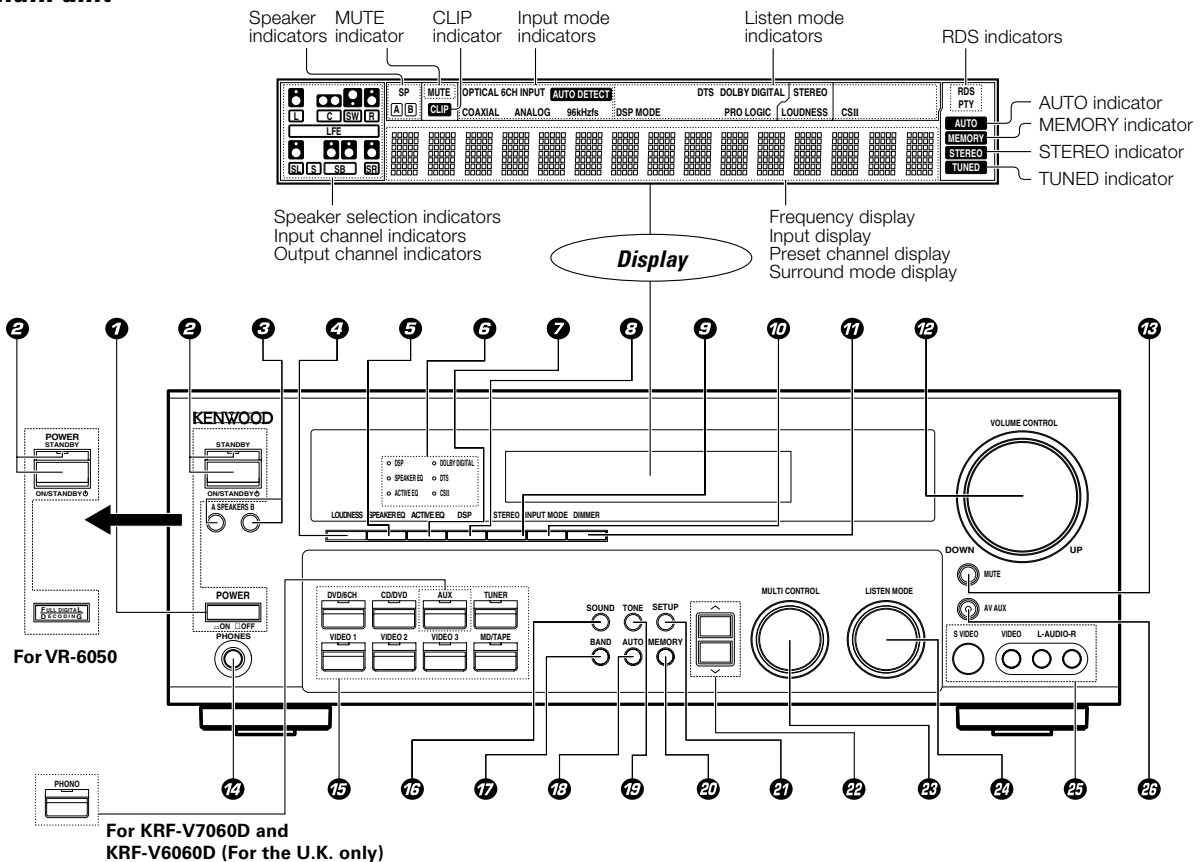

- 1 POWER ON/OFF key** (For KRF-V7060D/V6060D) - [18]  
Use to turn the main power ON/OFF.
- 2 ON/STANDBY  $\downarrow$  key** (For KRF-V7060D/V6060D) - [18]  
Use to turn the power ON/STANDBY when the POWER is turned ON.  
**STANDBY indicator**
- 3 POWER ON/STANDBY  $\downarrow$  key** (For VR-6050) - [18]  
Use to turn the power ON/STANDBY.  
**STANDBY indicator**
- 4 A SPEAKERS B keys** - [21]  
Use to turn the A/B speakers ON/OFF.
- 5 LOUDNESS key** - [22]  
Use to switch the status of LOUDNESS.
- 6 SPEAKER EQ key** - [22]  
Use to select SPEAKER EQ's setting.
- 7 Surround indicators**  
**DSP indicator** - [29]  
Lights when the receiver is in the DSP mode.  
**SPEAKER EQ indicator** - [22]  
Lights when the receiver is in the SPEAKER EQ mode.  
**ACTIVE EQ indicator** - [22]  
Lights when the receiver is in the ACTIVE EQ mode.  
**DOLBY DIGITAL indicator** - [29]  
Lights when the receiver is in the Dolby Digital mode.

- DTS indicator** - [29]  
Lights when the receiver is in the DTS mode.
- CS II indicator** - [29]  
Lights when the receiver is in the CIRCLE SURROUND II mode.
- 7 ACTIVE EQ key** - [22]  
Use to select ACTIVE EQ's setting.
- 8 DSP key** - [29]  
Use to select any of the DSP mode.
- 9 STEREO key** - [30]  
Use to switch the listen mode to STEREO.
- 10 INPUT MODE key** - [9]  
Use to switch between the full auto, digital and analog inputs.
- 11 DIMMER key** - [23]  
Use to select the REC MODE.  
Use to adjust the brightness of the display.
- 12 VOLUME CONTROL knob** - [21]  
**13 MUTE key** - [22]  
Use to temporarily mute the sound.
- 14 PHONES jack** - [22]  
Use for headphone listening.
- 15 Input Selector keys** - [21]  
**DVD/6CH, CD/DVD, AUX (for VR-6050/KRF-V6060D) or PHONO [for KRF-V7060D and KRF-V6060D (for the U.K. only)], TUNER, VIDEO 1, VIDEO 2, VIDEO 3, MD/TAPE**  
Use to select input sources.

- 16 SOUND key** - [30]  
Use to adjust the sound quality and the ambience effects.
- 17 BAND key** - [24]  
Use to select the broadcast band.
- 18 AUTO key** - [24]  
Use to select the auto or manual tuning mode.
- 19 TONE key** - [22]  
Use to switch the status of TONE control.
- 20 MEMORY key** - [24] - [26]  
Use to store radio stations in the preset memory and to start the Auto Memory (for the U.K. only).
- 21 SETUP key** - [18]  
Use to select the speakers' settings etc.
- 22  $\wedge/\vee$  keys** - [18]  
Use for selection adjustments during SOUND, SETUP and PRESET CHANNEL functions.
- 23 MULTI CONTROL knob** - [18]  
Use to control a variety of settings.
- 24 LISTEN MODE knob** - [29]  
Use to select the listening mode.
- 25 AV AUX (S VIDEO, VIDEO, L-AUDIO-R) jacks** - [16] - [16]  
**26 AV AUX key**  
Use to switch the input to AV AUX.

## Standby mode

While the standby indicator is lit, a small amount of power is supplied to the system to back up the memory. This is called standby mode. Under the condition, the system can be turned ON by remote control unit.

## Connection at POWER ON/OFF key (for KRF-V7060D/V6060D)

The power in this equipment will not be completely cut off from the AC wall outlet when the main switch is turned OFF.

## Remote control unit (RC-R0725) (KRF-V7060D) and (RC-R0727) (VR-6050/KRF-V6060D)

This remote control unit can be used not only for Kenwood products but also for other non-Kenwood products by setting the appropriate manufacturer's setup codes. - [35]

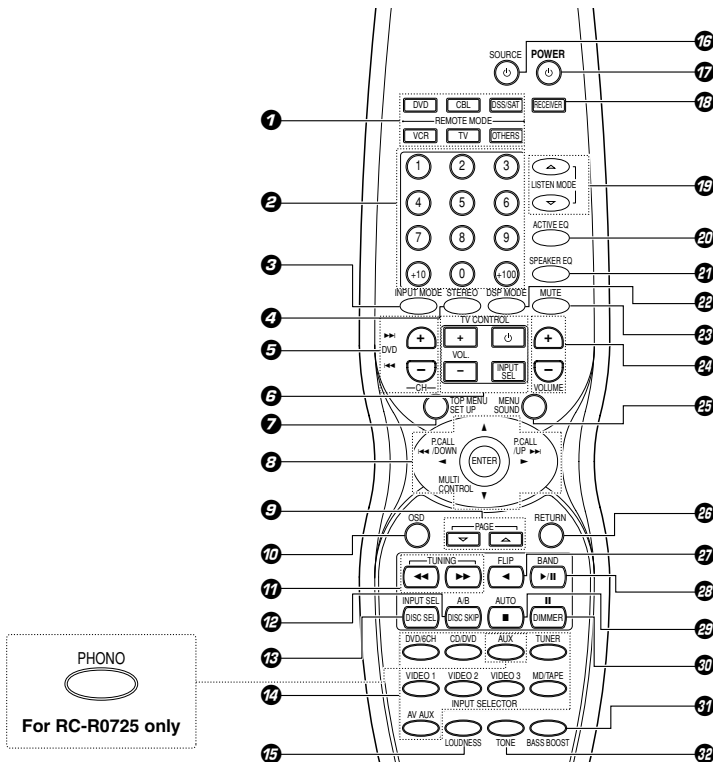

If the name of a function is different on the receiver and on the remote control, the name of the remote control key in this manual is indicated in parentheses.

- 1 REMOTE MODE keys (DVD, CBL, DSS/SAT, VCR, TV, OTHERS)** - [33]  
Use to select the components registered at the respective input.
- 2 Numeric keys** - [33]  
Provide functions identical to those of the original remote control supplied with the component you are controlling.
- 3 INPUT MODE key** - [9]  
Use to switch between the full auto, digital and analog inputs.
- 4 STEREO key** - [30]  
Use to switch the listen mode to STEREO.
- 5 CH +/- keys**  
Use to select the channels.  
**▶▶ DVD ◀◀ keys**  
When in DVD player operations, these keys function as skip keys.
- 6 TV CONTROL keys**  
Use when in TV operation.
- 7 TOP MENU key**  
Use to operate the DVD component.  
**SET UP key** - [18]  
Use to select the speakers' settings etc.
- 8 Joystick**  
**ENTER**  
Use to operate other components.  
**MULTI CONTROL ▲/▼** - [18]  
Use to control a variety of settings.  
Use to operate other components.  
**P.CALL ◀◀/DOWN ◀ and P.CALL/UP ▶▶** - [25]  
Use for selection adjustments during SOUND, SET UP and PRESET channel functions.
- 9 PAGE ▲/▼ keys**  
Use to operate the DVD component.
- 10 OSD key**  
Use to operate the DVD component.
- 11 TUNING ◀◀/▶▶ keys** - [24]  
Use to operate the tuner mode.  
If CD, MD or TAPE is selected as the input source, these keys function as search keys.
- 12 DISC SKIP key**  
If CD is selected as the input source, this key functions as the multi-CD player disc skip key.  
**A/B key**  
If TAPE is selected as the input source, this is A and B deck of a double cassette deck.
- 13 DISC SEL key**  
Use to operate other components.  
**INPUT SEL key**  
Use to operate other components.
- 14 INPUT SELECTOR keys [DVD/6CH, CD/DVD, AUX or PHONO (for RC-R0725 only), TUNER, VIDEO 1, VIDEO 2, VIDEO 3, MD/TAPE, AV AUX]**  
Use to select the input sources. - [21]
- 15 LOUDNESS key** - [22]  
Use to switch the status of LOUDNESS.
- 16 SOURCE (⏻) key**  
Use to turn the other components ON/OFF. - [18]
- 17 POWER (⏻) key** - [18]  
Use to turn the receiver ON/OFF.
- 18 RECEIVER key**  
Use to return to the operation of the receiver.
- 19 LISTEN MODE ▲/▼ keys** - [29]  
Use to select the listening mode.
- 20 ACTIVE EQ key** - [22]  
Use to select ACTIVE EQ's setting.
- 21 SPEAKER EQ key** - [22]  
Use to select SPEAKER EQ's setting.
- 22 DSP MODE key** - [29]  
Use to select any of the DSP mode.
- 23 MUTE key** - [22]  
Use to temporarily mute the sound.
- 24 VOLUME +/- keys** - [21]  
Use to adjust the receiver volume.
- 25 MENU key**  
Use to operate other components.  
**SOUND key** - [30]  
Use to adjust the sound quality and the ambience effects.
- 26 RETURN key**  
Use to operate other components.
- 27 ◀ key**  
Use to operate other components.
- 28 FLIP key**  
Use to operate other components.
- 29 ▶/II key**  
If CD is selected as the input source, this key functions as the play/pause key.  
If MD or TAPE key is selected as input source, this key functions as the play key.  
**BAND key** - [24]  
Use to select the broadcast band.
- 30 ■ key**  
If CD, MD, or TAPE is selected as the input source, this key functions as the stop key. - [24]  
**AUTO key** - [24]  
Use to select the auto or manual tuning mode.
- 31 DIMMER key** - [32]  
Use to adjust the brightness of the display.
- 32 II key**  
Use to operate other components.
- 33 BASS BOOST key** - [22]  
Use to select the maximum adjustment setting for the low frequency range.
- 34 TONE key** - [22]  
Use to switch the status of TONE control.

## Remote control unit (RC-R0726) (KRF-V6060D) (For the U.K. only)

This remote control unit can be used not only for Kenwood products but also for other non-Kenwood products by setting the appropriate manufacturer's setup codes. → [36]

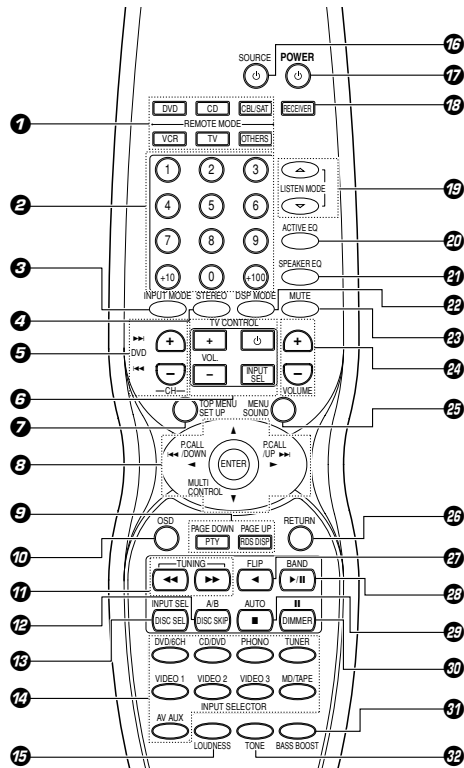

If the name of a function is different on the receiver and on the remote control, the name of the remote control key in this manual is indicated in parentheses.

- 1 REMOTE MODE keys (DVD, CD, CBL/SAT, VCR, TV, OTHERS)** → [33]  
Use to select the components registered at the respective input.
- 2 Numeric keys** → [33]  
Provide functions identical to those of the original remote control supplied with the component you are controlling.
- 3 INPUT MODE key** → [9]  
Use to switch between the full auto, digital and analog inputs.
- 4 STEREO key** → [30]  
Use to switch the listen mode to STEREO.
- 5 CH +/- keys**  
Use to select the channels.  
**▶▶ DVD ◀◀ keys**  
When in DVD player operations, these keys function as skip keys.
- 6 TV CONTROL keys**  
Use when in TV operation.
- 7 TOP MENU key**  
Use to operate the DVD component.  
**SET UP key** → [18]  
Use to select the speakers' settings etc.
- 8 Joystick**  
**ENTER**  
Use to operate other components.  
**MULTI CONTROL ▲/▼** → [18]  
Use to control a variety of settings.  
Use to operate other components.  
**P.CALL ◀◀/DOWN ◀ and P.CALL/UP ▶▶**  
▶ Use for selection adjustments during SOUND, SET UP and PRESET channel functions.
- 9 RDS DISP key** → [25]  
Use for RDS function.  
**PAGE DOWN key**  
Use to operate the DVD component.  
**PTY key** → [26]  
Use for PTY search.

- PAGE UP key**  
Use to operate the DVD component.
- 10 OSD key**  
Use to operate the DVD component.
- 11 TUNING ◀◀/▶▶ keys** → [24]  
Use to operate the tuner mode.  
If CD, MD or TAPE is selected as the input source, these keys function as search keys.
- 12 DISC SKIP key**  
If CD is selected as the input source, this key functions as the multi-CD player disc skip key.  
**A/B key**  
If TAPE is selected as the input source, this is A and B deck of a double cassette deck.
- 13 DISC SEL key**  
Use to operate other components.  
**INPUT SEL key**  
Use to operate other components.
- 14 INPUT SEL. keys [DVD/6CH, CD/DVD, PHONO, TUNER, VIDEO 1, VIDEO 2, VIDEO 3, MD/TAPE, AV AUX]**  
Use to select the input sources. → [21]
- 15 LOUDNESS key** → [22]  
Use to switch the status of LOUDNESS.
- 16 SOURCE (⏻) key**  
Use to turn the other components ON/OFF.
- 17 POWER (⏻) key** → [18]  
Use to turn the receiver ON/OFF.
- 18 RECEIVER key**  
Use to return to the operation of the receiver.
- 19 LISTEN MODE ▲/▼ keys** → [29]  
Use to select the listening mode.
- 20 ACTIVE EQ key** → [22]  
Use to select ACTIVE EQ's setting.
- 21 SPEAKER EQ key** → [22]  
Use to select SPEAKER EQ's setting.
- 22 DSP MODE key** → [29]  
Use to select any of the DSP MODE.

- 23 MUTE key** → [22]  
Use to temporarily mute the sound.
- 24 VOLUME +/- keys** → [21]  
Use to adjust the receiver volume.
- 25 MENU key**  
Use to operate other components.  
**SOUND key** → [30]  
Use to adjust the sound quality and the ambience effects.
- 26 RETURN key**  
Use to operate other components.
- 27 ◀ key**  
Use to operate other components.  
**FLIP key**  
Use to operate other components.
- 28 ▶/II key**  
If CD is selected as the input source, this key functions as the play/pause key.  
If MD or TAPE key is selected as input source, this key functions as the play key.  
**BAND key** → [24]  
Use to select the broadcast band.
- 29 ■ key**  
If CD, MD, or TAPE is selected as the input source, this key functions as the stop key.  
**AUTO key** → [24]  
Use to select the auto or manual tuning mode.
- 30 DIMMER key** → [32]  
Use to adjust the brightness of the display.  
**II key**  
Use to operate other components.
- 31 BASS BOOST key** → [22]  
Use to select the maximum adjustment setting for the low frequency range.
- 32 TONE key** → [22]  
Use to switch the status of TONE control.



# Setting up the system

Make connections as shown in the following pages. When connecting the related system components, be sure to refer to the instruction manuals supplied with the components you are connecting. Do not connect the power cord to a wall outlet until all connections are completed.

## Notes

1. Be sure to insert all connection cords securely. If their connections are imperfect, sound may not be produced or there will be noise interference.
2. Be sure to remove the power cord from the AC outlet before plugging or unplugging any connection cords. Plugging/unplugging connection cords without disconnecting the power cord can cause malfunctions and may damage the unit.
3. Do not connect power cords from components whose power consumption is larger than what is indicated on the AC outlet at the rear of this unit.

## Analog connections

Audio connections are made using RCA pin cords. These cables transfer stereo audio signal in an "analog" form. This means the audio signal corresponds to the actual audio of two channels. These cables usually have 2 plugs on each end, one red for the right channel and one white for the left channel. These cables are usually packed together with the source unit, or are available at your local electronics retailer.

## Microcomputer malfunction

If operation is not possible or an erroneous display appears, even though all connections have been made properly, reset the micro-computer referring to "In case of difficulty".

- 40 -

## CAUTION

Be sure to adhere to the following, or proper ventilation will be blocked causing damage or fire hazard.

- Do not place any objects impairing heat radiation onto the top of the unit.
- Leave some space around the unit (from the largest outside dimension including projection) equal to or greater than, shown below.

Top panel : 50 cm    Side panel : 10 cm    Back panel : 10 cm

## Input mode settings

CD/DVD, VIDEO 2 and DVD/6CH inputs each include jacks for digital audio input and analog audio input.

The initial factory settings for audio signal playback for CD/DVD, DVD/6CH and VIDEO 2 are full auto.

To use the analog audio input for playback instead (if, for example, you have connected a VCR to the VIDEO2 input), you must set the input mode for the corresponding input to the analog mode.

After completing connections and turning on the receiver, follow the steps below.

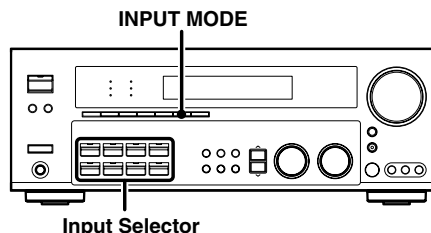

① Use the Input Selector keys to select CD/DVD, VIDEO 2 or DVD/6CH.

② Press the INPUT MODE key.

Each press switches the setting as follows:

In DTS play mode

- ① FULL AUTO (digital input, analog input)
- ② DIGITAL MANUAL (digital input)

In CD/DVD, VIDEO 2, DVD/6CH play mode

- ① FULL AUTO (digital input, analog input)
- ② DIGITAL MANUAL (digital input)
- ③ 6CH INPUT (DVD/6CH input)
- ④ ANALOG (analog input)

**Digital input:**

Select this setting to play digital signals from a DVD, CD, or LD player.

**Analog input:**

Select this setting to play analog signals from a cassette deck, VCR, or record player.

**Auto detect:**





In "FULL AUTO" mode (AUTO DETECT indicator light up), the receiver detects the digital or analog input signals automatically. Priority is given to digital signal during input mode selection. The receiver will select the input mode and listening mode automatically during playback to match the type of input signal (Dolby Digital, PCM, DTS) and the speaker setting. The OPTICAL and COAXIAL indicator on the display will light up when digital signal is detected. If the input signal is analog, the ANALOG indicator will light up.

To keep the receiver set to the currently selected listening mode, use the INPUT MODE key to select "DIGITAL MANUAL" (manual sound). However, even when this setting is selected, there may be cases in which the listening mode is selected automatically to match a Dolby Digital source signal depending on the combination of listening mode and source signal.

If the INPUT MODE key is pressed quickly, sound may not be produced. Press the INPUT MODE key again.

## Connecting audio components

Shape of AC outlets

U.S.A. and Canada	
U.K.	
Australia	
Other countries	

SYSTEM CONTROL  
jacks

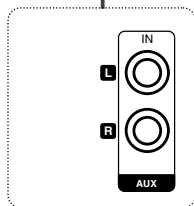
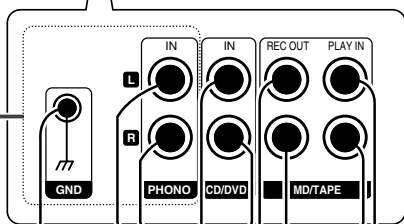
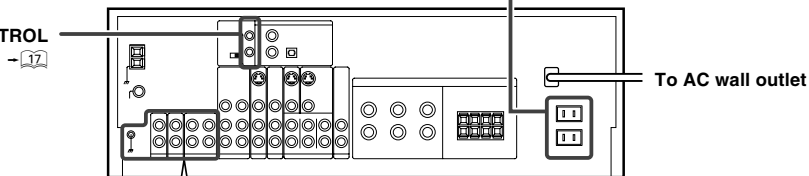

[For VR-6050 and  
KRF-V6060D  
(except for the U.K.)]

OUT  
IN  
Cassette deck or  
MD recorder

OUT  
CD or DVD player

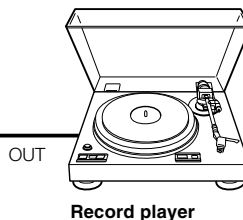

Record player

Moving coil (MC) cartridge record player cannot be used directly from the receiver unit. It can only be used when another equalizer amplifier is connected.

## Connecting video components

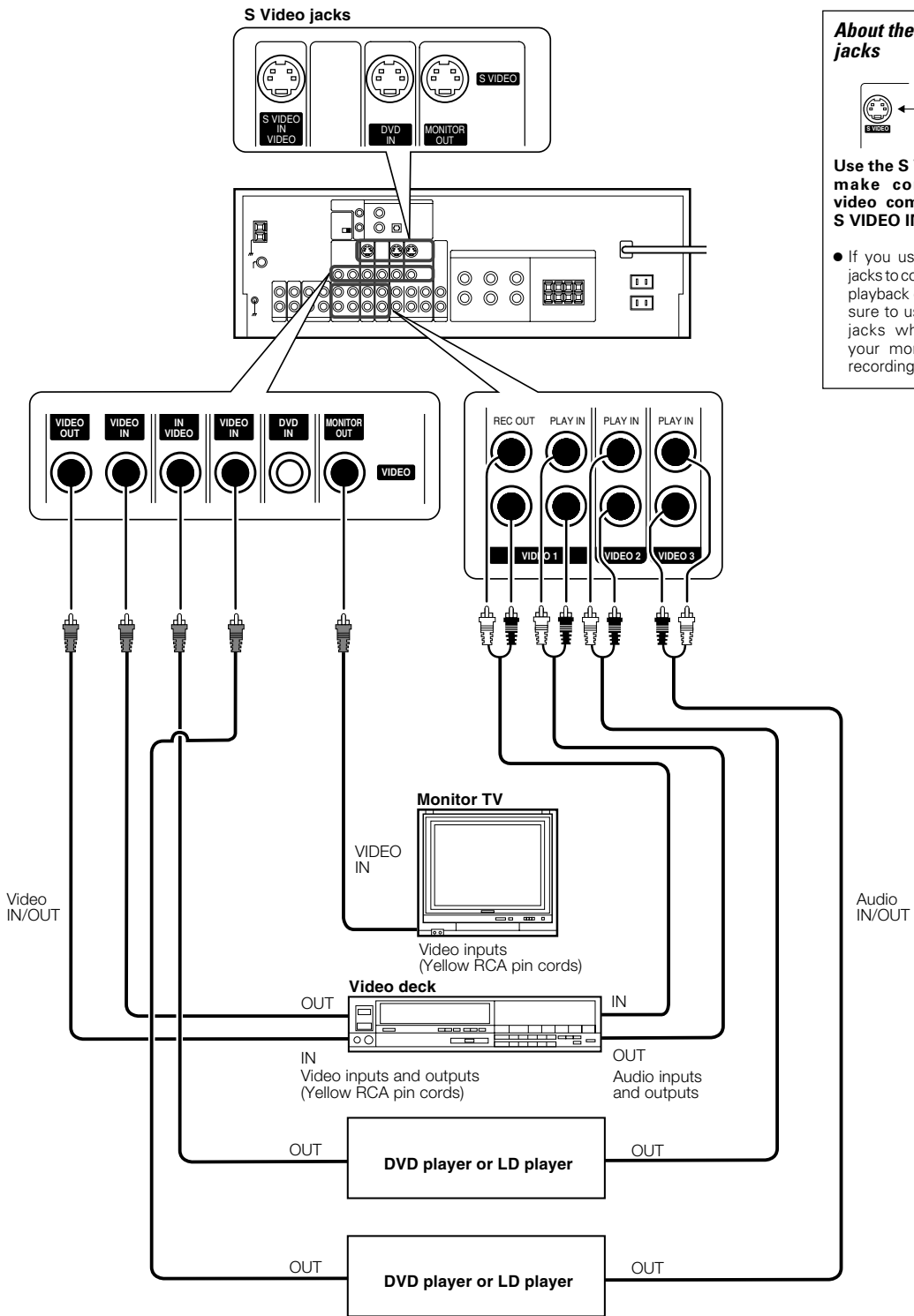

### About the S VIDEO jacks

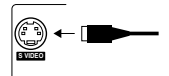

Use the **S VIDEO** jacks to make connections to video components with **S VIDEO IN/OUT** jacks.

- If you use the **S VIDEO** jacks to connect your video playback components, be sure to use the **S VIDEO** jacks when connecting your monitor and video recording components.

A video component with digital audio outputs should be connected to the VIDEO 2 jacks.

## Digital connections

The digital in jacks can accept DTS, Dolby Digital, or PCM signals. Connect components capable of outputting DTS, Dolby Digital, or standard PCM (CD) format digital signals.

If you have connected any digital components to the receiver, be sure to read the "Input mode settings" section carefully.

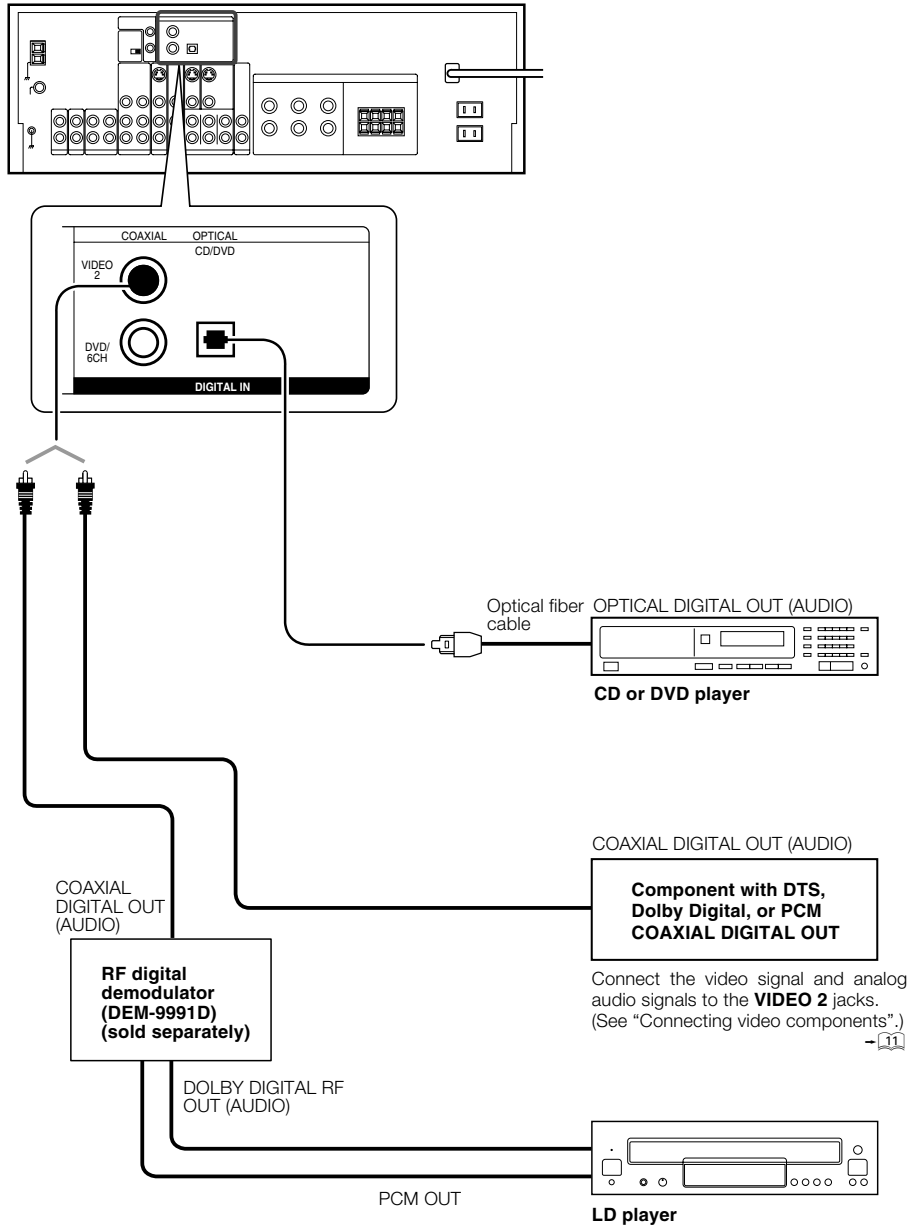

To connect an LD player with a DIGITAL RF OUT, connect the LD player to the KENWOOD RF digital demodulator (DEM-9991D). Next, connect the DIGITAL OUT jacks of the demodulator to the DIGITAL IN jacks of the receiver. Connect the video signal and analog audio signals to the VIDEO 2 jack. (See "Connecting video components".)

## Connecting a DVD player (6-channel input)

If you have connected a DVD player to the receiver with digital connection, be sure to read the "Input mode settings" section carefully.

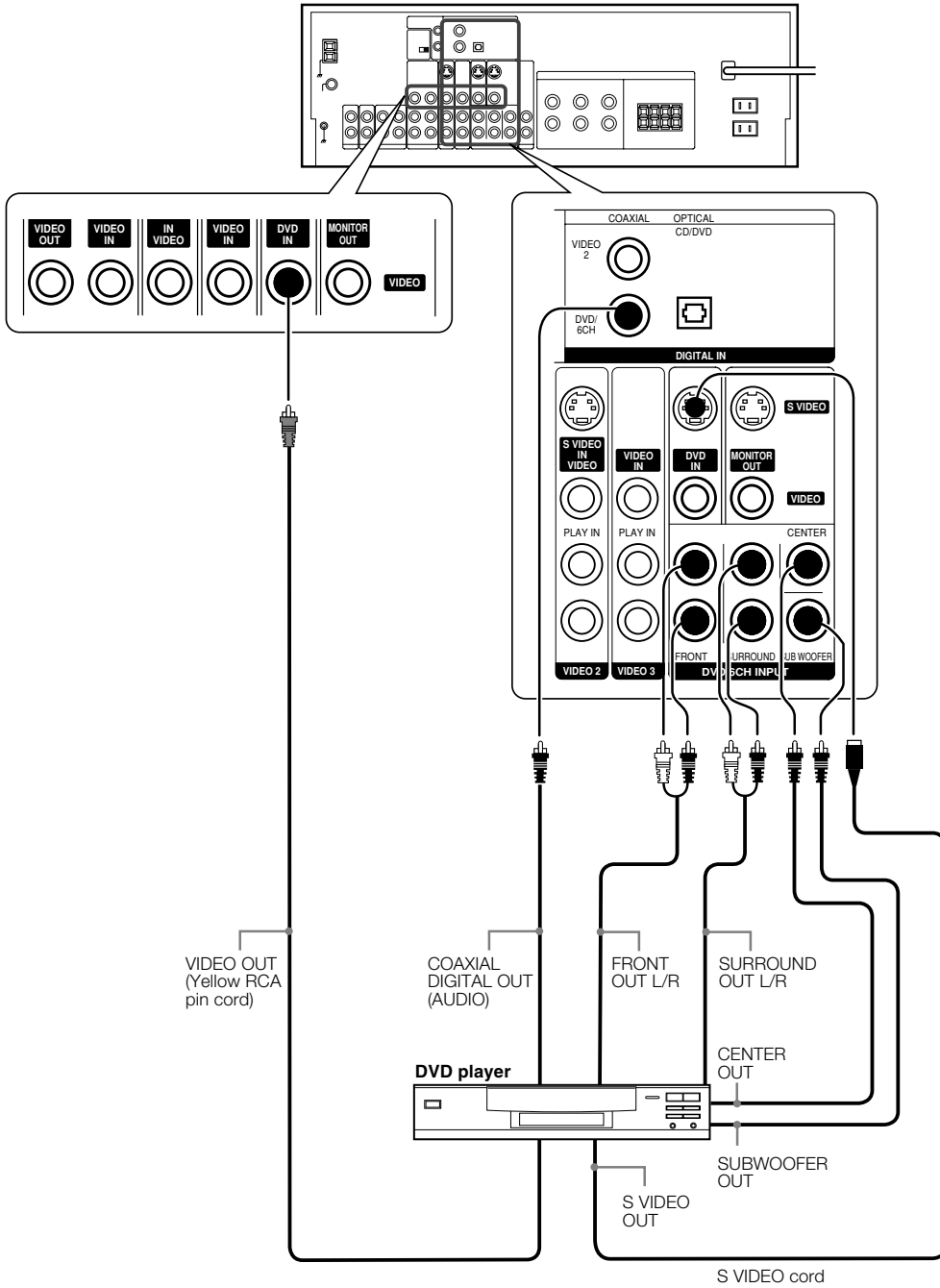

## Connecting the speakers

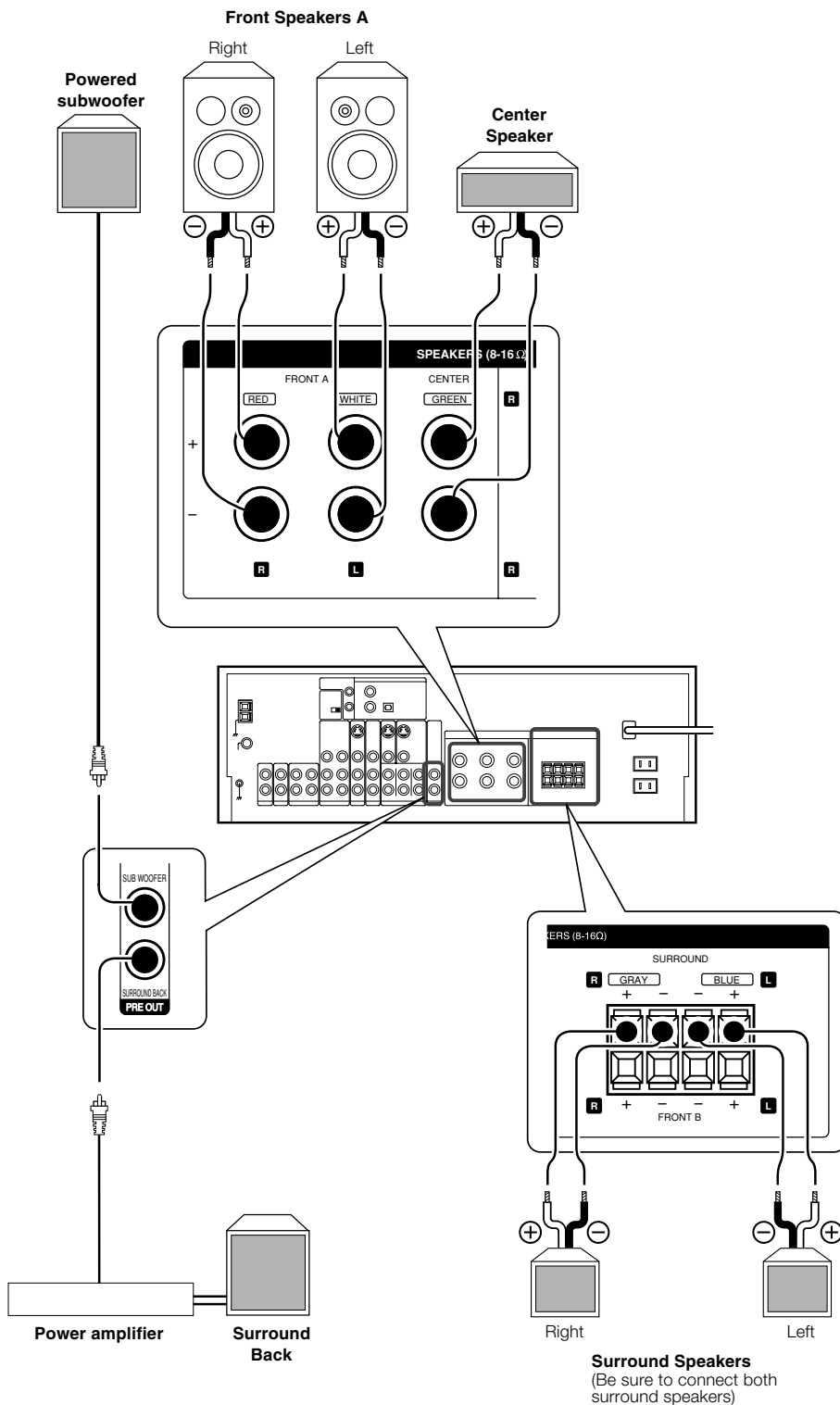

Use the **FRONT SPEAKERS B** terminals if you want to connect a second front speaker system.

## Connecting the terminals

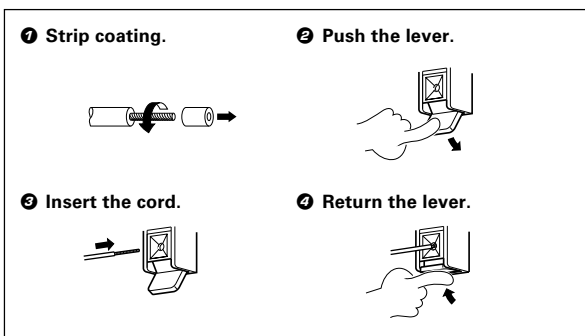
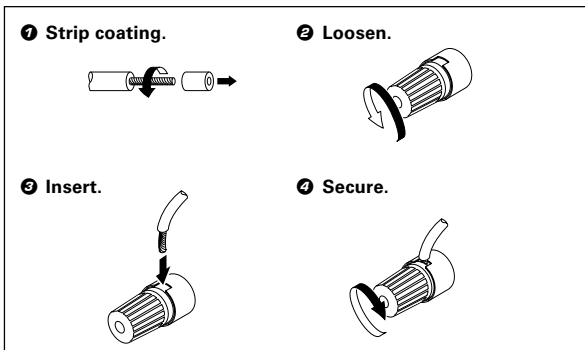

### Connection of banana plugs (For the U.S.A. and Canada)

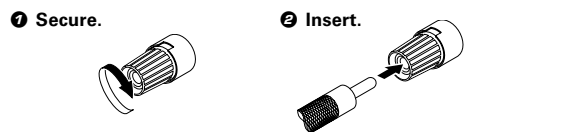

• Sound will not be heard if the speaker terminal is not fully secured.

- Never short circuit the + and – speaker cords.
- If the left and right speakers are connected inversely or the speaker cords are connected with reversed polarity, the sound will be unnatural with ambiguous acoustic imaging. Be sure to connect the speakers correctly.

### Speaker impedance

After confirming the speaker impedance indications printed on the rear panel of the receiver, connect speakers with matching impedance ratings. Using speakers with a rated impedance other than that indicated on the rear panel of the receiver could result in malfunctions or damage to the speakers or receiver.

### Speaker placement

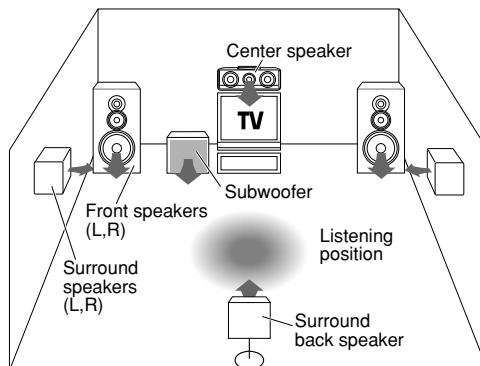

**Front speakers** : Place at the front left and right of the listening position. Front speakers are required for all surround modes.

**Center speaker** : Place front and center. This speaker stabilizes the sound image and helps recreate sound motion. Required for surround playback.

**Surround speakers** : Place at the direct left and right, or slightly behind, the listening position at even heights, approximately 1 meter above the ears of the listeners. These speakers recreate sound motion and atmosphere. Required for surround playback.

**Subwoofer** : Reproduces powerful deep bass sounds.

**Surround back speaker** : Place the speaker directly at the rear of the listening position. The optimum position depends mainly on the room condition.

- Although the ideal surround system consists of all the speakers listed above, if you don't have a center speaker or a subwoofer, you can divide those signals between the available speakers in the speaker settings steps to obtain the best possible surround reproduction from the speakers you have available.

### Channel space switching

(Except for the U.S.A., Canada, U.K., and Australia)

The space between radio channels has been set to the one that prevails in the area to which the system is shipped. However, if the current channel space setting does not match the setting in the area where the system is to be used, for instance when you move from area 1 or area 2 shown in the following table or vice versa, proper reception of AM/FM broadcasts cannot be expected. In this case, change the channel space setting in accordance with your area by referring to the following table.

	Area	CHANNEL Space Frequency
1	U.S.A., Canada and South American countries	FM: 100 kHz AM: 10 kHz
2	Other countries	FM: 50 kHz AM: 9 kHz

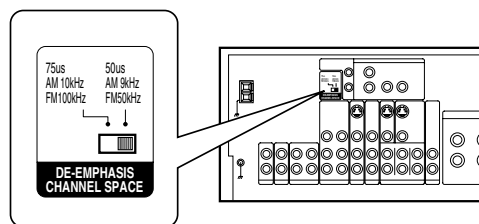

Turn the power OFF by pressing the POWER key before moving the switch level. Move switch lever to match your area with a small screwdriver or other pointed tool, then turn the power on again.

## Connecting to the AV AUX jacks

The **AV AUX** jacks are convenient for connection of video components such as a camcorder or a video game.

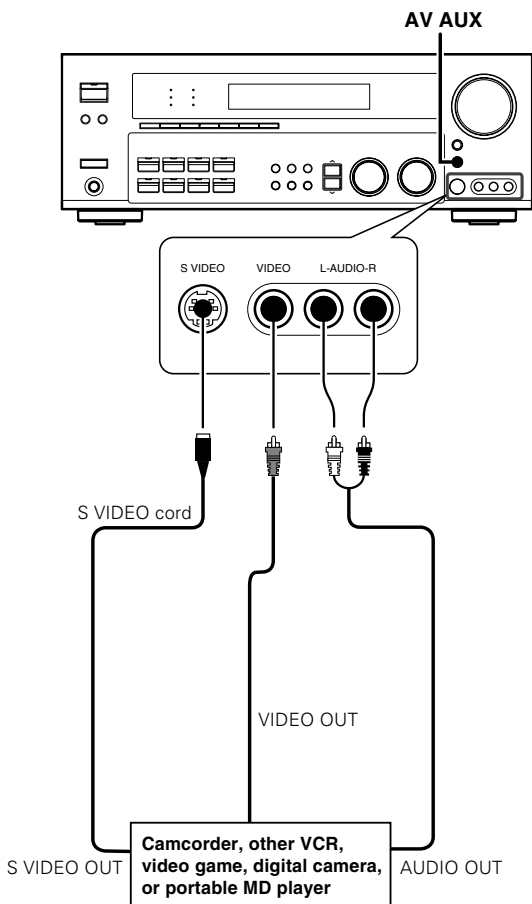

- To select the source connected to the AV AUX jacks press AV AUX key. — 21
- When you connect the audio source such as the MD player, you do not need to connect the video cable.
- When you connect the unit and the component with the S VIDEO cord, you can get better picture quality.

## Connecting the antennas

### AM loop antenna

The supplied loop antenna is for use indoors. Place it as far as possible from the receiver, TV set, speaker cords and power cord, and adjust the direction for best reception.

#### AM antenna terminal connections

- 1 Push lever.
- 2 Insert cord.
- 3 Release lever.

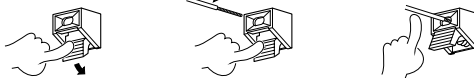

### FM indoor antenna

The supplied indoor antenna is for temporary use only. For stable signal reception we recommend using an outdoor antenna. Disconnect the indoor antenna when you connect one outdoors.

#### FM antenna terminal connections

Insert cord.



### FM outdoor antenna

Lead the 75Ω coaxial cable connected to the FM outdoor antenna into the room and connect it to the FM 75Ω terminal.

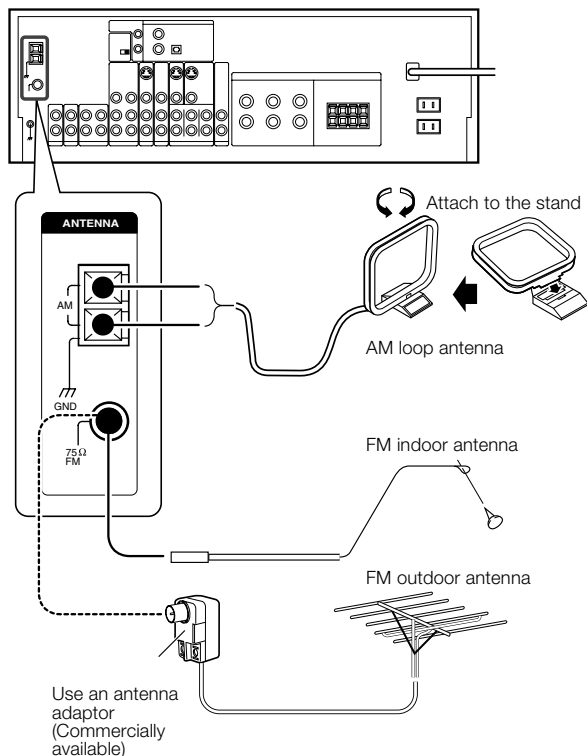



## Connecting the system control

Connecting system control cords after connecting a KENWOOD audio component system lets you take advantage of convenient system control operations.

This unit is compatible only with the [SL16] mode. The system control operation is not available if the unit is connected in the [XS8], [XS], or [XR] connection mode.

If your component has the mode select switch, set the connected components to the [SL16] mode.

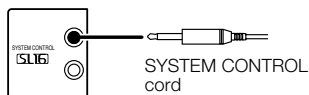

You may connect the system control cord to either the up or down jack.

### EXAMPLE: [SL16] mode connections

The underlined portion represents the setting of the system control mode.

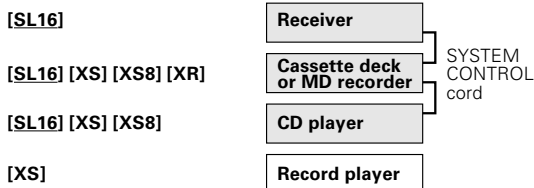

- In order to take advantage of the system control operations, the components must be connected to the correct jacks. To use a CD player it must be connected to the CD jacks. To use a cassette deck (or MD recorder) it must be connected to the MD/TAPE jacks. When using more than one CD player (etc.) only the one connected to the specified jacks may be connected for system control.
- Some CD players and cassette decks are not compatible with the [SL16] system control mode. Do not make system connections with equipment that is not [SL16] compatible.
- Some MD players are not system control compatible. You cannot make system control connections to this kind of equipment.

### Notes

- [SL16] equipment cannot be combined with [XR], [XS], and [XS8] equipment for system operations. If your equipment consists of this kind of combination, please do not connect any system control cords. Even without system control cords, normal operations can be carried out without effecting performance.
- Do not connect system control cords to any components other than those specified by KENWOOD. It may cause a malfunction and damage your equipment.
- Be sure the system control plugs are inserted all the way in to the system control terminals.

## SYSTEM CONTROL OPERATIONS

### Remote Control

Lets you operate this unit with the system remote supplied with the receiver.

### Automatic Operation

When you start playback from a source component, the input selector on this unit switches to that component automatically.

### Synchronized Recording

Lets you synchronize recording with the start of playback when recording from CD, MD or analog discs.

## Registering setup codes for KENWOOD audio components

If you own remote controllable KENWOOD audio components that are not compatible with system control, registering the setup code enables you to control those components using the remote control supplied with this unit (without connecting system control cords). To register setup codes for your remote controllable KENWOOD audio components, see "Registering setup codes for other components".

## Preparing the remote control

### Loading the batteries

1 Remove the cover.

2 Insert the batteries.

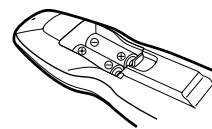
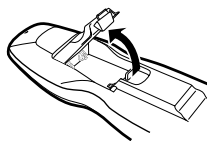

3 Close the cover.

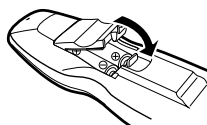

Insert two AA-size (R6) batteries as indicated by the polarity markings.

### Operation

When the **STANDBY** indicator is lit, the power turns ON when you press the **POWER**  $\phi$  key on the remote control. When the power comes ON, press the key you want to operate.

Operating range (Approx.)

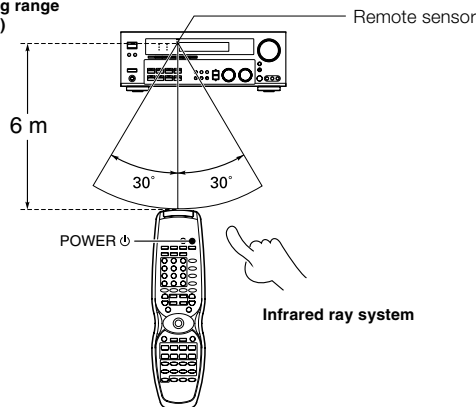

- When pressing more than one remote control key successively, press the keys securely by leaving an interval of 1 second or more between keys.

### Notes

- The supplied batteries may have shorter lives than ordinary batteries due to use during operation checks.
- When the remote-controllable distance gets shorter than before, replace both batteries with new ones.
- Placing the remote sensor in direct sunlight, or in direct light from a high frequency fluorescent lamp may cause a malfunction. In such a case, change the location of the system installation to prevent malfunction.

# Preparing for surround sound

## Speaker settings

To enable you to obtain optimum enjoyment from the receiver's listening modes, make sure to complete the speaker settings (subwoofer, front, center, and surround speakers) as described below.

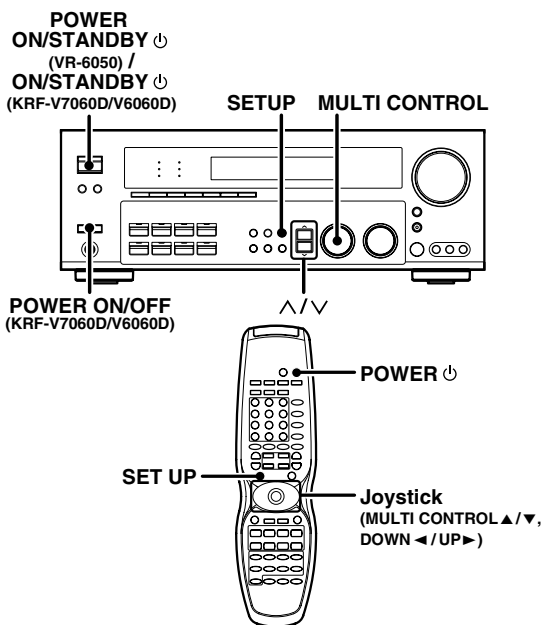

**1 Turn on the power to this receiver by pressing the POWER ON/STANDBY ⏻ (for VR-6050) or POWER ON/OFF and ON/STANDBY ⏻ (KRF-V7060D/V6060D) or POWER ⏻ key.**

**2 Press the SETUP key to enter the SET UP mode and press  $\wedge/\vee$  keys or Joystick ( $\leftarrow/\rightarrow$ ) for the following displays.**

- ① SP SETUP
- ② TEST TONE
- ③ SP DISTANCE
- ④ DISP MODE
- ⑤ EXIT

The flow of the SET UP is as follows:

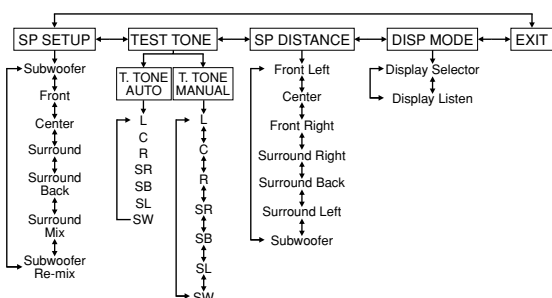

**3 Select a speaker system.**

**1 Select the SP SETUP and press the SETUP key again so that the subwoofer setting indication "SUBW ON" appears.**

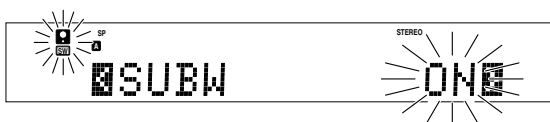

**2 Use the MULTI CONTROL knob or Joystick ( $\blacktriangle/\blacktriangledown$ ) to select the appropriate subwoofer setting.**

- ① **SUBW ON** : Subwoofer setting mode to the receiver is ON.
- ② **SUBW OFF** : Subwoofer setting mode to the receiver is OFF.

- The initial setting is "SUBW ON".
- When the setting "SUBW OFF" is selected, the front speakers are automatically set to "FRNT LARGE" and the procedure skips to step 4.
- Before step 4, press the SETUP key to accept the setting.
- When subwoofer output sound is required, select "FRNT NORMAL" or select both "FRNT LARGE" and "SW RE-MIX ON".

**3 Press the  $\wedge$  key or Joystick ( $\rightarrow$ ) to accept the setting.**

- The front speakers setting indication "FRNT" appears.

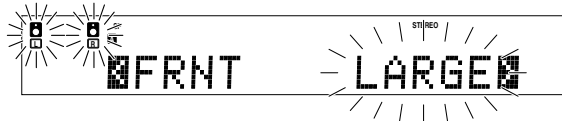

**4 Use the MULTI CONTROL knob or Joystick ( $\blacktriangle/\blacktriangledown$ ) to select the appropriate front speakers setting.**

- ① **FRNT LARGE** : Large front speakers are connected to the receiver.
- ② **FRNT NORMAL** : Average size front speakers are connected to the receiver.

- For "FRNT LARGE" selection, no sound will be heard from subwoofer speaker even when it is set to ON. However, if you select "SW RE-MIX ON" when subwoofer is selected, you will be able to hear sound from the subwoofer.
- When in STEREO mode, the sound goes directly to front speaker.

**5 Press the  $\wedge$  key or Joystick ( $\rightarrow$ ) to accept the setting.**

- The center speaker setting indication "CNTR" appears.

**6 Use the MULTI CONTROL knob or Joystick ( $\blacktriangle/\blacktriangledown$ ) to select the appropriate center speaker setting.**

**If you selected "LARGE" as the front speakers setting,**

- ① **CNTR LARGE** : A large center speaker is connected to the receiver.
- ② **CNTR NORMAL** : An average size center speaker is connected to the receiver.
- ③ **CNTR OFF** : Center speaker setting mode to the receiver is OFF.

**If you selected "NORMAL" as the front speakers setting,**

- ① **CNTR ON** : Center speaker setting mode to the receiver is ON.
- ② **CNTR OFF** : Center speaker setting mode to the receiver is OFF.

**7 Press the  $\wedge$  key or Joystick ( $\rightarrow$ ) again to accept the setting.**

- The surround speaker setting indication "SURR" appears.

**8 Use the MULTI CONTROL knob or Joystick ( $\blacktriangle/\blacktriangledown$ ) to select the appropriate surround speaker setting.**

**If you selected "LARGE" as the center speaker setting,**

- ① **SURR LARGE** : Large surround speakers are connected to the receiver.
- ② **SURR NORMAL** : Average size surround speakers are connected to the receiver.
- ③ **SURR OFF** : Surround speaker setting mode to the receiver is OFF.

If you selected other than "LARGE" as the center speaker setting,

- ① **SURR ON** : Surround speaker setting mode to the receiver is ON.
- ② **SURR OFF** : Surround speaker setting mode to the receiver is OFF.

• When the setting "SURR OFF" is selected, the procedure skips to step ⑩.

⑨ Press the **^** key or Joystick (**▶**) again to accept the setting.  
• The surround speaker setting indication "SB" appears.

⑩ Use the **MULTI CONTROL** knob or Joystick (**▲/▼**) to select appropriate surround back speaker setting.

If you selected "LARGE" as the surround speaker setting,

- ① **SB NORMAL** : Average size surround back speaker is connected to the receiver.
- ② **SB LARGE** : Large surround back speaker is connected to the receiver.
- ③ **SB OFF** : Surround back speaker setting mode to the receiver is OFF.

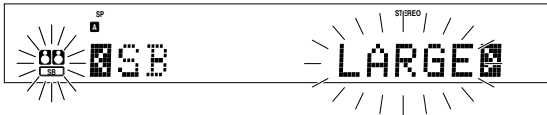

If you selected "NORMAL" as the surround speaker setting,

- ① **SB ON** : Surround back speaker setting mode to the receiver is ON.
- ② **SB OFF** : Surround back speaker setting mode to the receiver is OFF.

⑪ Press the **^** key or Joystick (**▶**) again to accept the setting and "SURR:MIX" appears.

• Surr:mix is when the SL and SR speakers signals are mixed to produce sound from the surround back speaker which would enable the listener to enjoy sound coming from the back.

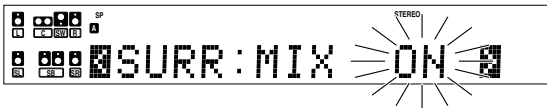

⑫ Use the **MULTI CONTROL** knob or Joystick (**▲/▼**) to select the following.

- ① **SURR:MIX ON** : Surround mix setting mode to the receiver is ON.
- ② **SURR:MIX OFF** : Surround mix setting mode to the receiver is OFF.

• If surround back speaker is turned OFF, SURR:MIX setting is not visible and the procedure skips to step ⑬.

⑬ Press the **^** key or Joystick (**▶**) again to accept the setting.  
• The subwoofer re-mix setting indication "SW RE-MIX" appears.

⑭ Use the **MULTI CONTROL** knob or Joystick (**▲/▼**) to select the appropriate subwoofer re-mix setting.

- ① **SW RE-MIX ON** : Subwoofer re-mix setting mode to the receiver is ON.
- ② **SW RE-MIX OFF** : Subwoofer re-mix setting mode to the receiver is OFF.

• If subwoofer is turned OFF, subwoofer re-mix setting is not visible.

⑮ Press the **SETUP** key again to return to the main setup displays.

- The receiver enters the speaker volume level adjustment mode.
- In steps ⑫ and ⑬, indications appear only for the selected channels of the speakers that require adjusting.

#### ④ Adjust the speaker volume level.

From your usual listening position, adjust the volume levels. The volume levels from each speaker should be the same.

① Press the **^/▼** keys or Joystick (**◀/▶**) to select **TEST TONE**.

② Press the **SETUP** key for the following displays:

- ① **T.TONE AUTO**
- ② **T.TONE MANUAL**

③ The selection of **AUTO/MANUAL TEST TONE** is done by the **MULTI CONTROL** knob or Joystick (**▲/▼**). Press the **SETUP** key again to begin **TEST TONE**.

Use the **MULTI CONTROL** knob or Joystick (**▲/▼**) to adjust the volume level of the test tone output from the speaker channel to be adjusted.

For **AUTO** selection, the first test tone is heard from the front left speaker for 2.5 seconds. The next test tone is heard from the speakers in the following sequence for 2 seconds each.

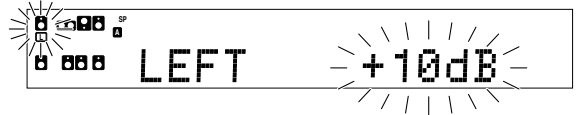
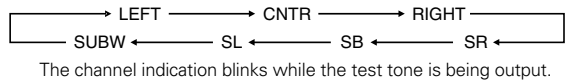

• If you change the volume level settings for the speakers while listening to music, the settings referred to on this page are also changed.

• If the speaker setting selects are OFF, the speaker level settings are reset.

For **MANUAL** selection, press the **^/▼** keys or Joystick (**◀/▶**) each time to select the speaker channel.

④ Press the **SETUP** key again.

• The test tone is turned off and return to the main setup displays.

#### ⑤ Input the distance to the speakers.

① Press the **^/▼** keys or Joystick (**◀/▶**) to select the **SP DISTANCE** on setup displays and press the **SETUP** key again.

② Measure the distance from the listening position to each of the speakers.

**Jot down the distance to each of the speakers.**

- Distance to Front left speaker (L) : \_\_\_ feet (meters)
- Distance to Center speaker (C) : \_\_\_ feet (meters)
- Distance to Front right speaker (R) : \_\_\_ feet (meters)
- Distance to Surround right (SR) : \_\_\_ feet (meters)
- Distance to Surround back (SB) : \_\_\_ feet (meters)
- Distance to Surround left (SL) : \_\_\_ feet (meters)
- Distance to Subwoofer (SW) : \_\_\_ feet (meters)

③ Use the **^/▼** keys or Joystick (**◀/▶**) to select the speakers and the **MULTI CONTROL** knob or Joystick (**▲/▼**) to adjust the distance to the front speakers.

The speaker indicator to be adjusted blinks.

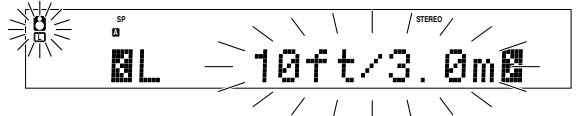

Indication in feet      Indication in meters

• The allowable setting range is 1 to 30 feet (0.3 to 9.0 m), adjustable in 1 foot (0.3 m) increments.

④ Repeat steps ③ to input the distance for each of the speakers.

Continued to next page

- 5 Press the **SETUP** key again to return to main setup displays.
  - The speakers you have selected should appear on the display. Confirm that all the speakers have been correctly selected.

**6 Select the display mode.**

- 1 Press the **^/∨** keys or Joystick (**◀/▶**) to select the **DISP MODE**.
- 2 Press the **SETUP** key for the following displays:
  - ① **DISP SELECTOR** : Displays the current input selector.
  - ② **DISP LISTEN** : Displays the current listen mode.
- 3 Use the **MULTI CONTROL** knob or Joystick (**▲/▼**) to select the display mode.



- 4 Press the **SETUP** key again to accept the setting.
- 5 Use the **^** key or Joystick (**▶**) to select **EXIT**.

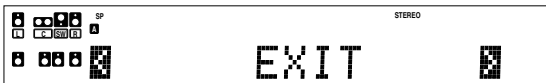

- 6 Press the **SETUP** key to exit the SET UP mode.

**Input level adjustment (analog sources only)**

If the input level of an analog source signal is too high, the CLIP indicator will blink to indicate the source signal. Adjust the input level.



- 1 Use the **Input Selector** keys to select the source of which the input level you want to adjust.
  - You can store a separate input level for each input source.
- 2 Press the **SOUND** and **^/∨** keys or Joystick (**◀/▶**) repeatedly until the "INPUT" indication appears.
- 3 Use the **MULTI CONTROL** knob or Joystick (**▲/▼**) to adjust the input level.

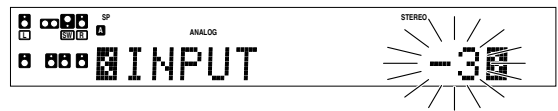

- The adjustment mode is displayed for approximately 8 seconds.
- The input level may be adjusted to any one of three settings: 0dB, -3dB, and -6dB. (The initial setting is 0dB.)

- 4 Press the **SOUND** key again to return to the input indication.

# Normal playback

## Preparing for playback

Some preparatory steps are needed before starting playback.

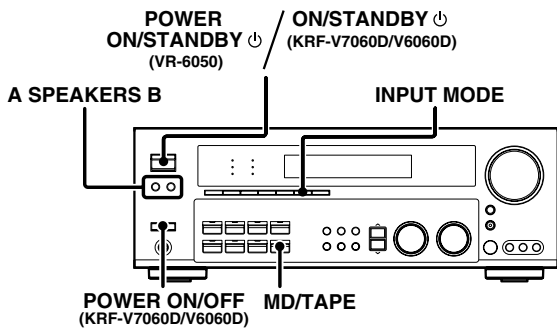

### Turning on the receiver

- 1 Turn on the power to the related components.
- 2 Turn on the power to this receiver by pressing the POWER ON/STANDBY ⏻ (for VR-6050) key or POWER ON/OFF and ON/STANDBY ⏻ (for KRF-V7060D/V6060D) key.

### Selecting the input mode

If you have selected a component connected to the CD/DVD, VIDEO 2 or DVD/6CH jacks, make sure that the input mode setting is correct for the type of audio signal to be used. 

### Selecting MD/TAPE

Select the source name corresponding to the component connected to the MD/TAPE jacks. The initial factory setting is "TAPE". To change the source to "MD", follow the steps below:

Hold down the MD/TAPE key for more than 2 seconds.

- The source indication changes to "MD".
- To return to the original indication, repeat the above procedure.

### Selecting the speaker system

Press the A SPEAKERS B key to select the speaker system to be used.

- A ON** : Sound from the speakers connected to the SPEAKERS A terminals on the rear panel.
- B ON** : Sound from the speakers connected to the SPEAKERS B terminals on the rear panel. No sound will be heard from the subwoofer.
- A+B ON** : Sound from both the speakers connected to the SPEAKERS A and B terminals on the rear panel.
- A+B OFF** : No sound from the speakers. Use this setting when listening with headphones for stereo sound in all playback modes. The display segments are different depending on the type of input signal.

The indicator for the speakers you want to use should be lit.

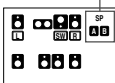

- Selecting "6CH INPUT" by pressing the INPUT MODE key, whereby "DVD/6CH" is the input source will cause SPEAKERS A to be selected automatically.

## Listening to a source component

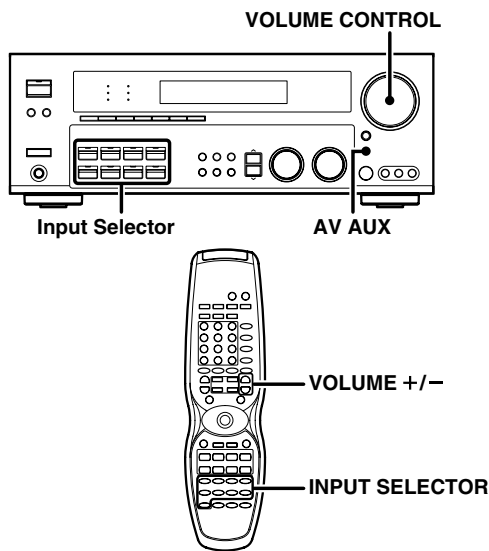

- 1 Use the Input Selector and AV AUX keys to select the source you want to listen to.

Selecting a source using each key.

#### VR-6050/KRF-V7060D/V6060D

- 1 "DVD/6CH"
- 2 "CD/DVD"
- 3 "AUX" or "PHONO" (for KRF-V7060D only)
- 4 "TUNER"
- 5 "VIDEO 1"
- 6 "VIDEO 2"
- 7 "VIDEO 3"
- 8 "MD/TAPE"
- 9 "AV AUX"

#### KRF-V6060D (for the U.K. only)

- 1 "DVD/6CH"
- 2 "CD/DVD"
- 3 "PHONO"
- 4 "TUNER"
- 5 "VIDEO 1"
- 6 "VIDEO 2"
- 7 "VIDEO 3"
- 8 "MD/TAPE"
- 9 "AV AUX"

- 2 Start playback from the selected source.

- 3 Use the VOLUME CONTROL knob or VOLUME +/- keys to adjust the volume.

## Adjusting the sound

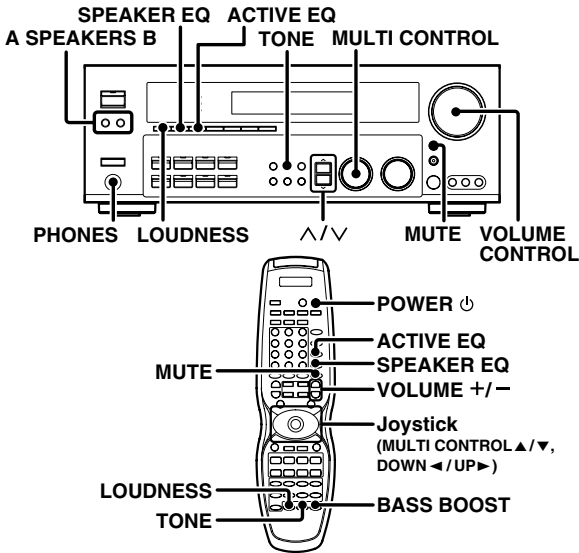

### Adjusting the TONE

You can adjust the sound quality when the receiver is in the PCM stereo and analog stereo mode.

- 1 Press the **TONE** key to select the TONE mode.
- 2 Use the **MULTI CONTROL** knob or Joystick ( $\blacktriangle/\blacktriangledown$ ) to select TONE ON/OFF.

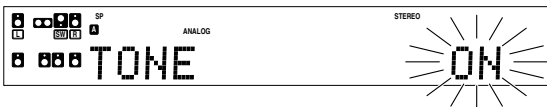

- 3 When in TONE ON selection, press the **TONE** key for the following displays.

**BASS** : Select this to adjust the low frequency range.  
**TREBLE** : Select this to adjust the high frequency range.

- 4 Use the **MULTI CONTROL** knob or Joystick ( $\blacktriangle/\blacktriangledown$ ) to adjust the sound quality.

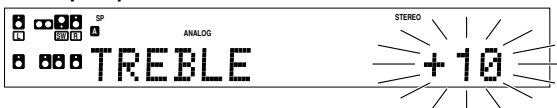

- The bass and treble levels are adjustable from -10 to +10 in 2 step increments.
- The adjustment item is displayed for approximately 8 seconds.

### Once-touch low frequency emphasis (BASS BOOST) (remote control only)

You can adjust the sound quality when the receiver is in the PCM stereo and analog stereo modes.

Press the **BASS BOOST** key.

- Press the key once to select the maximum (+10) low frequency emphasis setting.
- This key does not function when the receiver is in the sound quality or ambience effects adjustment mode.

### Switching back to the previous setting

Press the **BASS BOOST** key again.

### Adjusting the LOUDNESS mode

You can adjust the Loudness function which controls the low volume settings to maintain the music's richness. The adjustment can be made when the receiver is in the PCM stereo and analog stereo mode.

Press the **LOUDNESS** key to turn the LOUDNESS setting ON.

### To cancel

Press the **LOUDNESS** key again so that the "LOUDNESS" indicator goes off.

### Muting the sound

The **MUTE** key lets you mute the sound of the speakers.

Press the **MUTE** key.

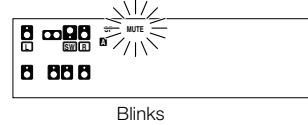

### To cancel

Press the **MUTE** key again so that the "MUTE" indicator goes off.

- MUTE ON can also be deactivated by turning the VOLUME CONTROL knob or pressing VOLUME +/- keys.

### ACTIVE EQ mode

You can enjoy a more impressive sound effect when ACTIVE EQ is turned ON during Dolby Digital and DTS playback and, when in PCM and analog stereo mode.

Press the **ACTIVE EQ** key for the following selections;

- 1 **ACTIVE EQ MUSIC** : Effective when listening to music. (The ACTIVE EQ indicator lights up.)
- 2 **ACTIVE EQ CINEMA** : Effective when watching a movie. (The ACTIVE EQ indicator lights up.)
- 3 **ACTIVE EQ TV** : Effective when watching TV. (The ACTIVE EQ indicator lights up.)
- 4 **ACTIVE EQ OFF** : The ACTIVE EQ function is turned OFF. (The ACTIVE EQ indicator goes off.)

- "ACTIVE EQ" will scroll from right to left.
- When ACTIVE EQ and SPEAKER EQ are OFF and ACTIVE EQ (MUSIC) is turned ON, SPEAKER EQ (SMALL) will turn ON automatically.
- ACTIVE EQ function will not be available when REC MODE, AUTO TUNING or PRESET MEMORY is ON, and during 96kHz LPCM playback.

### SPEAKER EQ mode

SPEAKER EQ's function will automatically detect the various features of each speaker and effectively creates a stereoscopic sound effect.

Press the **SPEAKER EQ** key to switch the following setting;

- 1 **SPEAKER EQ SMALL** : To select a small size speaker. (The SPEAKER EQ indicator lights up.)
- 2 **SPEAKER EQ NORMAL** : To select an average size speaker. (The SPEAKER EQ indicator lights up.)
- 3 **SPEAKER EQ LARGE** : To select a large size speaker. (The SPEAKER EQ indicator lights up.)
- 4 **SPEAKER EQ OFF** : The SPEAKER EQ function is turned OFF. (The SPEAKER EQ indicator goes off.)

- "SPEAKER EQ" will scroll from right to left.
- SPEAKER EQ cannot be turned OFF when ACTIVE EQ is turned ON.
- SPEAKER EQ function will not be available when REC MODE, AUTO TUNING or PRESET MEMORY is ON, and during 96kHz LPCM playback.

### Listening with headphones

- 1 Press the **A** and **B Speaker** keys so that the speaker indicator goes off.

Make sure the **SPEAKERS** indicators are turned off.

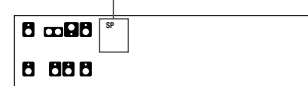

- If you turn off all of the speakers when in surround mode, the surround mode will be canceled as well, resulting in stereo playback.

- 2 Connect headphones to the **PHONES** jack.



- 3 Use the **VOLUME CONTROL** knob or **VOLUME +/-** keys to adjust the volume.

# Recording

## Recording audio (analog sources)

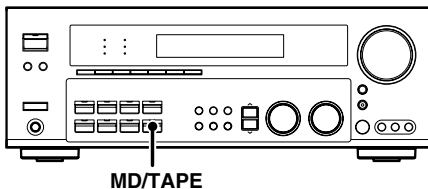

### Recording a music source

- 1 Use the Input Selector keys to select the source (other than "MD/TAPE") you want to record.
- 2 Set the MD or TAPE recorder to record.
- 3 Start playback, then start recording.

### Recording video

- 1 Use the Input Selector keys to select the video source (other than "VIDEO 1") you want to record.
- 2 Set the video deck connected to VIDEO 1 to record.
  - Select the REC MODE to record a digital input source.
- 3 Start playback, then start recording.
  - Recording may not be normal for some video software. This is due to the copy guard condition. → 49

## Recording audio (digital sources)

Switch on the **REC MODE** to record a digital input source. Usually use the **AUTO REC MODE** to record audio input sources. When the digital mode changes during recording in the **AUTO REC MODE**, the audio input source may be interrupted momentarily.

### Recording music in AUTO REC or MANUAL REC mode

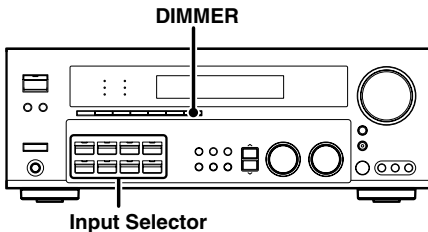

- 1 Use the Input Selector keys to select the source (CD/DVD, DVD/6CH, VIDEO 2) you want to record.
- 2 Set the MD or TAPE recorder to record.

- 3 Press and hold the DIMMER key for more than 2 seconds to select the **AUTO REC** or **MANUAL REC** mode.

- 1 **REC MODE off** : The digital input record mode is switched off.
- 2 **AUTO REC mode** : The digital input signals (DTS, Dolby Digital, or PCM) are identified automatically and converted into stereo signals that are ready for recording.
- 3 **MANUAL REC mode** : The input signal type at the moment this mode is selected is held throughout this mode.

For **AUTO REC** mode :

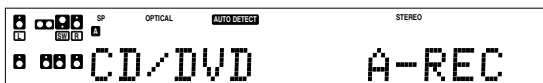

For **MANUAL REC** mode :



- 4 Start playback, then start recording.

- If the audio reproduction stops in the middle due to change in the input signals, etc., press the **DIMMER** key.

# Listening to radio broadcasts

The receiver can store up to 40 stations in the memory and recall them by one-touch operation.

Radio stations can be classified into RDS (Radio Data System) stations and other stations. To listen to or store RDS stations in the preset memory see "Using RDS (Radio Data System)". (For the U.K. only)

## Tuning (non-RDS) radio stations

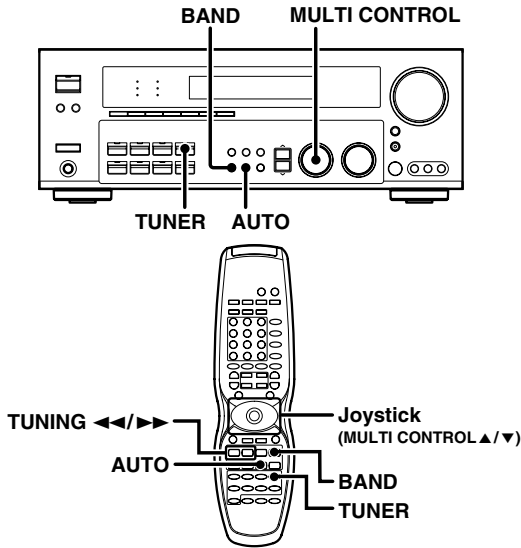

**1** Use the **TUNER** key to select the tuner.

**2** Use the **BAND** key to select the desired broadcast band.

Each press switches the band.

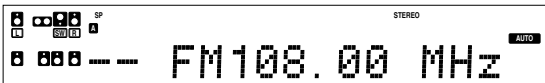

**3** Use the **AUTO** key to select the desired tuning method.

Each press switches the tuning method to either auto or manual tuning.

"**AUTO**" indicator lights up in the display.

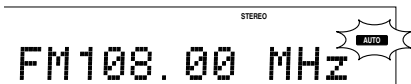

- Normally, set to "AUTO" (auto tuning). If the radio waves are weak and there is a lot of interference, switch to manual tuning. (With manual tuning, stereo broadcasts will be received in monaural.)

**4** Use the **MULTI CONTROL** knob or **Joystick** (▲/▼), or **TUNING** ◀/▶ keys to select the station.

"**STEREO**" lights when a broadcast is being received in stereo.

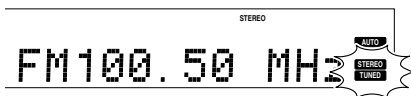

"**TUNED**" is displayed when a station is received.

- Auto tuning** : The next station is tuned automatically.
- Manual tuning** : Turn the knob or use the Joystick (▲/▼) to select the desired station.

## (For the U.K. only) Using RDS (Radio Data System)

RDS is a system that transmits useful information (in the form of digital data) for FM broadcasts along with the broadcast signal. Tuners and receivers designed for RDS reception can extract the information from the broadcast signal for use with various functions, such as automatic display of the station name.

### RDS functions:

#### PTY (Program Type Identification) Search

- [26]

Automatically tunes to a station that is currently broadcasting the specified program type (genre).

#### PS (Program Service Name) Display

Automatically displays the station name transmitted by the RDS station.

#### RDS AUTO MEMORY function

- [26]

Automatically selects and stores up to 40 RDS stations in the preset memory.

If fewer than 40 RDS stations have been stored in the preset memory, regular FM stations will be stored in the remaining places.

#### Radio Text function

Displays the radio text data transmitted by some RDS stations when you press the **RDS DISP** (display) key. There is "NO RT" if no text data is transmitted.

The "**RDS**" indicator lights up when an RDS broadcast (signal) is received.

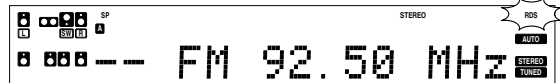

Note

Some functions and function names may differ for certain countries and areas.

Before using a function utilizing the RDS, be sure to perform the RDS Auto Memory operation by referring to the description in "Presetting RDS stations (RDS AUTO MEMORY)".

- [26]

## Presetting radio stations manually

The RDS auto memory function assigns preset numbers to RDS stations starting from preset number "1". Therefore, be sure to execute the RDS auto memory function before using the following operations to manually store AM stations and other FM stations, and RDS stations. See "Presetting RDS stations (RDS AUTO MEMORY)". (For the U.K. only)

- [26]

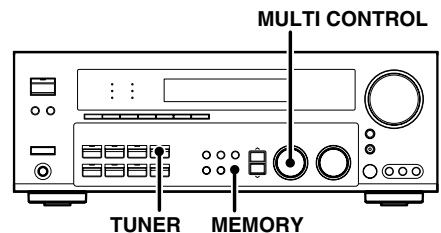

**1** Tune to the station you want to store.

**2** Press the **MEMORY** key while receiving the station.

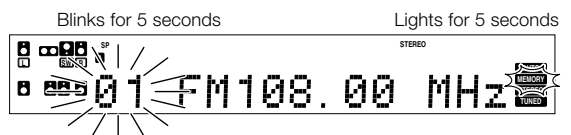



Proceed to step 2 within 5 seconds.  
(If more than 5 seconds elapse, press the MEMORY key again).

3 Use the MULTI CONTROL knob or Joystick (▲/▼) to select one of the station presets (1 – 40).

4 Press the MEMORY key again to confirm the setting.

- Repeat steps 1, 2, 3, and 4 to store as many stations as necessary.
- If you store a station at a previously used preset, the old station will be replaced by the new one.

## Receiving preset stations

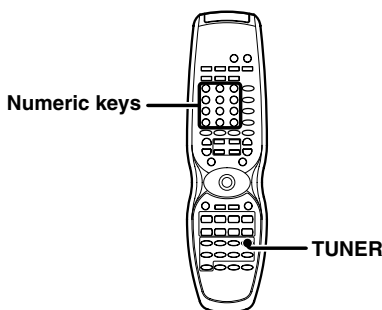

1 Press the TUNER key to select tuner as the source.

2 Enter the number of the preset station you want to receive (up to "40").

Press the numeric keys in the following order:

For "15", press **+10**, **5**  
For "20", press **+10**, **+10**, **0**

- If you make a mistake entering a two digit number, press the +10 key repeatedly to return to the original display and start again.



## Receiving preset stations in order (P.CALL)

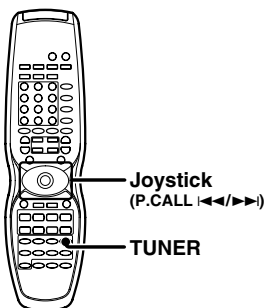

1 Press the TUNER key to select the tuner as the source.

2 Use the Joystick to adjust the P.CALL ◀▶ direction to select the desired station.

- Each time you push the Joystick, another preset station is received in order.

Pushing the Joystick to P.CALL ▶▶ does the following:

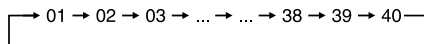

Pushing the Joystick to P.CALL ◀◀ does the following:

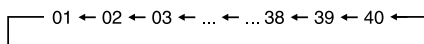

Holding the Joystick on ▶▶ or ◀◀ direction, lets you skip through the presets, receiving each preset station at 0.5 second intervals.

(For the U.K. only)

## Using the RDS DISP (Display) key

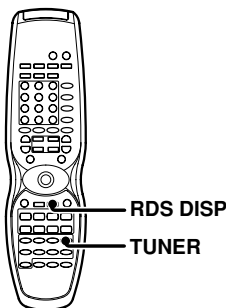

Pressing the RDS DISP key changes the contents of the display.

Each press switches the display mode as follows :

- 1 PS (Program Service name) display
- 2 RT (Radio Text) display
- 3 Frequency display

1 PS (Program Service name) display :

The station name is displayed automatically when an RDS broadcast is received.

If no PS data was sent, "NO PS" is displayed.



2 RT (Radio Text) display :

Text data accompanying the RDS broadcast scrolls across the display. "NO RT" is displayed if the current RDS station does not provide RT data.

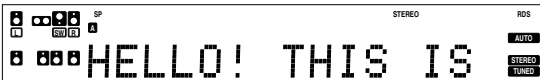

3 Frequency display :

Displays the frequency of the current station.

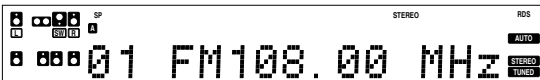

(For the U.K. only)

### Presetting RDS stations (RDS AUTO MEMORY)

This function automatically stores up to 40 RDS stations in the preset memory. In order to use the PTY function, the RDS stations must be stored in the preset memory using the RDS AUTO MEMORY function.

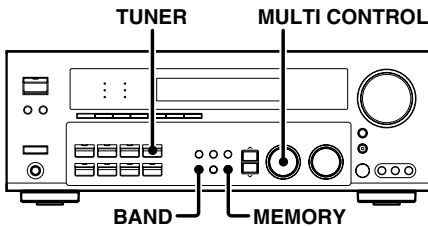

**1** Press the **TUNER** key to enter tuner mode.

**2** Use the **BAND** key to set the broadcast band to "FM".

**3** Press the **MEMORY** key continuously for more than 3 seconds will start **AUTO MEMORY**.

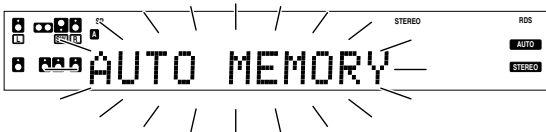

- After a few minutes, up to 40 RDS stations are preset in order from channel "01".
- Stations already stored in the preset memory may be replaced by RDS stations. (i.e., If the RDS AUTO MEMORY function detects 15 RDS stations, the stations currently preset at numbers 01~15 will be replaced by the RDS stations.)

(For the U.K. only)

### Tuning by Program Type (PTY search)

This function lets you set the tuner to automatically search for stations which are currently broadcasting the type of program (genre) you want to listen to.

Under certain receiving conditions, it may take more than 1 minute to complete the search.

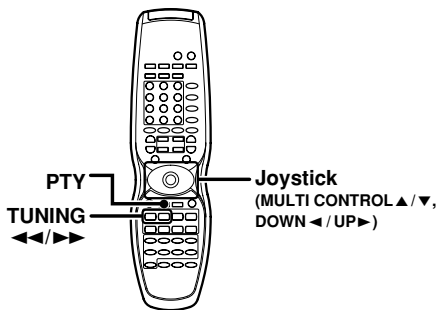

#### Preparations

- Execute the RDS auto memory procedure.
- Set the broadcast band to FM.
- Tune to an RDS station.

**1** Press the **PTY** key to activate the **PTY** search mode.



When an RDS broadcast is received, the program type is shown on the display. If no PTY data is available, or if the station is not an RDS station, "NONE" is displayed.

**2** While the "PTY" indicator is lit, use the Joystick (▲/▼) or **TUNING** ◀ / ▶ keys select the program type of your choice.

#### Program type table

Program Type Name	Display	Program Type Name	Display
Pop Music	POP M	Weather	WEATHER
Rock Music	ROCK M	Finance	FINANCE
Easy Music	EASY M	Children's Program	CHILDREN
Light Classical Music	LIGHT M	Social Affairs	SOCIAL
Serious Classical Music	CLASSICS	Religion	RELIGION
Other Music	OTHER M	Phone In	PHONE IN
News	NEWS	Travel	TRAVEL
Current Affairs	AFFAIRS	Leisure	LEISURE
Information	INFO	Jazz Music	JAZZ
Sport	SPORT	Country Music	COUNTRY
Education	EDUCATE	National Music	NATION M
Drama	DRAMA	Oldies Music	OLDIES
Culture	CULTURE	Folk Music	FOLK M
Science	SCIENCE	Documentary	DOCUMENT
Varied Speech	VARIED		

"NO PROGRAM" is displayed if this operation is attempted before performing the RDS Auto Memory operation.

**3** Press the **PTY** key to start searching.

**EXAMPLE** : Searching for a Pop Music broadcast.

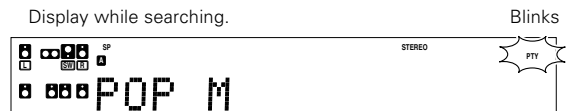

Program type name display

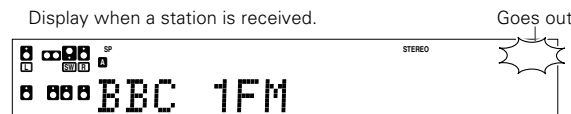

Station name display

- No sound is heard while "PTY" is blinking.
- If the desired program type cannot be found, "NO PROGRAM" is displayed, then after several seconds the display returns to the original display.

**To select another program type.**

Repeat steps **1**, **2** and **3**.

# Ambience effects

This receiver is equipped with listening modes that allow you to enjoy an enhanced sonic ambience with a variety of video sources.

In order to obtain the optimum effect from the surround modes, make sure to input the proper speaker settings beforehand.

→ 18

## Surround modes

### Dolby Digital

The Dolby Digital surround format lets you enjoy up to 5.1 channels of digital surround sound from Dolby Digital program sources (such as Laserdisc or DVD software marked **DD** **DOLBY DIGITAL**). Compared with previous Dolby surround, Dolby Digital provides even better sound quality, greater spatial accuracy, and improved dynamic range.

#### Note

Although a full set of speakers (front left, right, and center, surround left and right, and a subwoofer) is required for true 5.1 channel Dolby Digital surround sound, this receiver lets you enjoy Dolby Digital (and Dolby Surround) program sources, even if you connect only the front speakers.

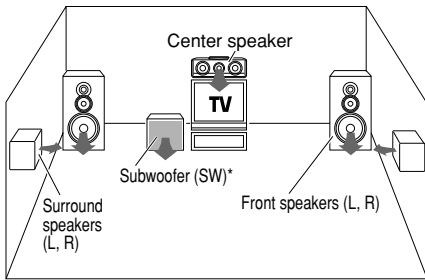

\* Optional in this mode.

\* LFE = Low Frequency Effects. This channel delivers separate non-directional bass signals to the subwoofer for more dynamic deep bass sound effects.

Although only Dolby Digital soundtracks incorporate a separate low frequency channel, connecting a subwoofer will also improve deep bass performance in the other surround modes.

The indication "LFE" appears in the display when a signal is being input for this channel.

"DTS" and "DTS Digital Surround" are trademarks of Digital Theater Systems, Inc.



Manufactured under license from Dolby Laboratories. "Dolby", "Pro Logic" and the double-D symbol are trademarks of Dolby Laboratories.

"Circle Surround II and the **CS**® symbol are trademarks of SRS Labs, Inc. Circle Surround II technology is incorporated under license from SRS Labs, Inc".

### Dolby Digital EX

Dolby Digital EX is an extension of Dolby Digital technology, Dolby Digital EX creates six full-bandwidth output channels from 6.1-channel sources. This is done using a matrix decoder that derives three surround channels from the two in the original recording. This is achieved by using three different surround signals, surround left, surround right, and surround back, each driving its own array of speakers. Think of it as adding a center channel for the rear speakers, which give more diffuse and natural surround effect, even if you wanted the ability to completely encircle the audience with sound, positioning sound effects exactly where they would be heard in real life. For best results, Dolby Digital EX should be used with movie soundtracks recorded with Dolby Digital Surround EX which contain a digital flag that will automatically activate this feature. However, for titles released prior to late 2001, this feature has to be activated manually.

#### Note

Although a full set of speakers (front left, right, and center, surround left and right, surround back and a subwoofer) is required for true 6.1 channel Dolby Digital Surround EX sound, this receiver lets you enjoy Dolby Digital (and Dolby Surround) program sources, even if you connect only the front speakers.

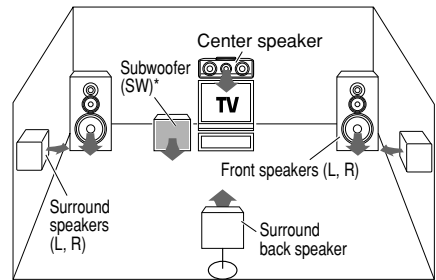

\* Optional in this mode.

\* LFE = Low Frequency Effects. This channel delivers separate non-directional bass signals to the subwoofer for more dynamic deep bass sound effects.

Although only Dolby Digital soundtracks incorporate a separate low frequency channel, connecting a subwoofer will also improve deep bass performance in the other surround modes.

The indication "LFE" appears in the display when a signal is being input for this channel.

### Dolby PRO LOGIC II

Dolby Pro Logic II was designed specifically to provide a new sense of spatiality, directionality and articulation of sounds from Dolby Surround encoded sources (such as video and Laserdisc software marked **DD** **DOLBY SURROUND**). This is achieved with an intelligent, built-in feedback logic design, a matrix surround decoding and the decoding of stereo, full bandwidth surround outputs. The PRO LOGIC II modes programmed into this receiver are "MOVIE", "MUSIC" and "PRO LOGIC". The "MOVIE" mode of the PRO LOGIC II has preset characteristics to produce a calibrated, high-level surround sound playback while the "MUSIC" mode has user-adjustable characteristics to offer the three optional controls, like "Dimension", "Center Width" and "Panorama" modes to allow optimization of the soundfields as desired. The "Dimension" control allows the user to gradually adjust the soundfield either towards the front or towards the rear; the "Center Width" control allows various adjustment of the left-center-right speakers' balance; the "Panorama" extends the front stereo image to include the surround speakers for an exciting "wraparound" effect with side wall imaging.

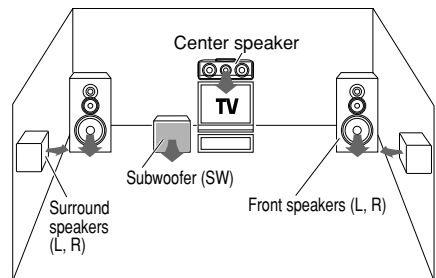

**Multi channel surround sound (SRS Circle Surround II)**

SRS Circle Surround II™ improves on its predecessor CS-5.1™ resulting in the CS-6.1™ system, enabling you to listen to realistic, multi-channel, surround sound playback from a stereo source or conventional surround-encoded video source. You already enjoy listening to Dolby Digital sound/DTS multi-channel sound with your multi-speakers. Now you can listen to audio CDs, MDs, Broadcast and Home Theater using your multi-speakers. You will discover a new type of sound through SRS Circle Surround II.

The CS system dramatically reduces storage space requirements for multi-channel content. It creates a listening environment that places the listener "inside" music performances, and dramatically improves both hi-fi audio and conventional surround-encoded video material. The CS decoder also includes the SRS technologies Focus™ and TruBass™. Focus electronically raises the sound stage from the speaker location to an optimal position. TruBass creates deep, rich bass in small speaker systems without the need for a subwoofer.

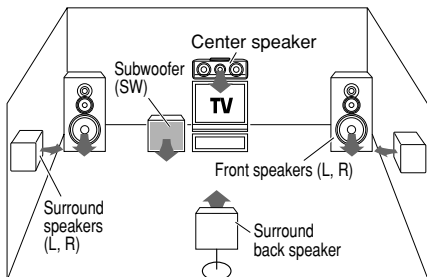

**DVD 6-channel mode**

Using a DVD player or the like equipped with six (5.1) output channels and the receiver, you can enjoy multi-channel encoded DVD source material in all its splendor. Since the source signals are digital and each channel is input independently, the resulting sound quality, sense of spaciousness, and dynamic range are superb.

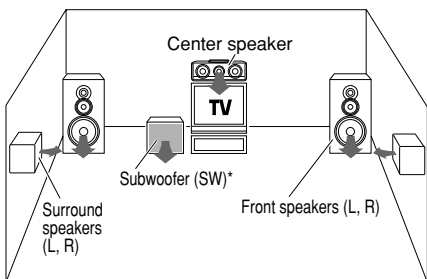

\* LFE = Low Frequency Effects. This channel delivers separate non-directional bass signals to the subwoofer for more dynamic deep bass sound effects.

**DSP mode**

The DSP mode lets you add the atmosphere of a live concert or hall to almost any type of program source. These modes are particularly effective when used with stereo program sources, like CD, television, and FM radio. You might enjoy trying the ARENA, JAZZ CLUB, THEATER, STADIUM or DISCO mode the next time you watch a concert or sporting event!

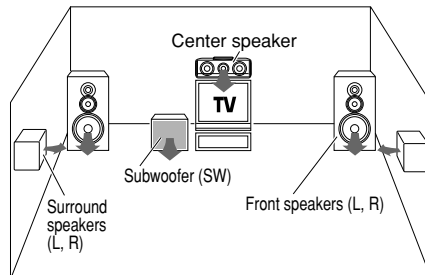

**What's DSP?**

DSP stands for Digital Signal Processor. The way a sound is heard in an actual environment depends on a variety of different factors. One of the most important is reverberation (the act of decaying elements of sound echoing in various places). The DSP modes produce the feeling of presence by using the DSP to create reverberation, without spoiling the sound quality of the original signal.

**DTS**

The DTS multi-channel audio format is available on CD, LD and DVD software. DTS is a strictly digital format and cannot be decoded inside most CD, LD or DVD players. For this reason, if you attempt to listen to DTS encoded software through the analog output of your new CD, LD or DVD player, you will experience digital noise in most cases. This noise can be quite loud if the analog output is connected directly to a high power amplification system. Proper measures for playing the digital output as described below should be taken to avoid this situation. To enjoy DTS Digital Surround playback, an external 5.1 channel DTS Digital Surround decoder must be connected to the digital output (S/P DIF, AES/EBU or TosLink) of a CD, LD or DVD player. All models are incorporated with the DTS decoder.

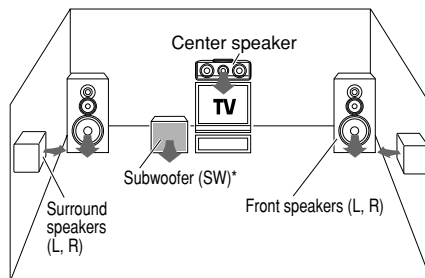

\* Optional in this mode.

\* LFE = Low Frequency Effects. This channel delivers separate non-directional bass signals to the subwoofer for more dynamic deep bass sound effects. DTS has a .1 or LFE channel. The indication "LFE" appears in the display when a signal is being input for this channel.

## Surround play

The DTS compatible models can reproduce a CD, DVD, or LD carrying the DTS mark.

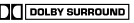
DOLBY DIGITAL can be used when playing DVD or LD software bearing the  mark and DOLBY DIGITAL format digital broadcasts (etc.). DOLBY PRO LOGIC can be used when playing video, DVD, or LD software bearing the  mark.

SRS Circle Surround II enables you to listen to multi channel sound from the stereo source.

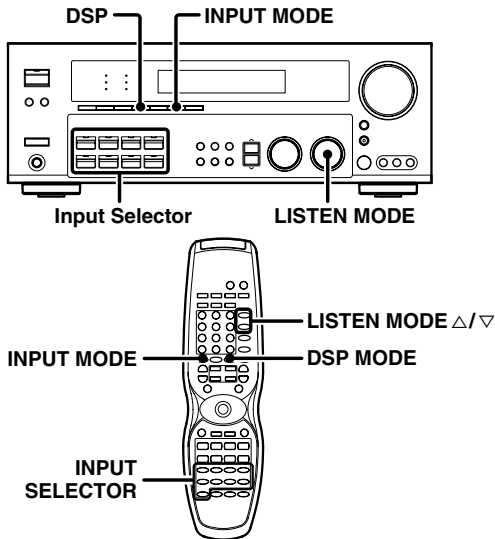

### Preparations

- Turn ON related components.
- Complete "Preparing for surround sound" (speaker settings). → [18]
- Use the **INPUT SELECTOR** keys to select the component you wish to play back with surround sound.
- Use the **INPUT MODE** key to select the input mode (analog or digital) for the source you wish to play back. → [9]
- Noise will be produced when a DTS source is played by selecting the analog input.

### 1 Start playing the video software.

### 2 Use the LISTEN MODE knob or LISTEN MODE Δ/▽ keys to select the listening mode.

The listening mode settings are stored separately for each input. If the input mode is set to full auto ("AUTO DETECT" lights), the receiver selects the optimal listening mode automatically based on the type of input signal and the speaker settings.

Each turn of the LISTEN MODE knob or press of the LISTEN MODE Δ/▽ keys switches the setting as listed below.

The listening mode settings are different depending on the type of input signal.

### When the DOLBY DIGITAL or DOLBY DIGITAL EX signal is input :

(The DOLBY DIGITAL or PRO LOGIC, indicator lights up.)

- 1 **DOLBY DIGITAL** : DOLBY DIGITAL surround.
- 2 **DOLBY D EX** : DOLBY DIGITAL EX surround.
- 3 **PLII MOVIE** : PRO LOGIC II surround MOVIE mode.  
(The PRO LOGIC indicator lights up.)
- 4 **PLII MUSIC** : PRO LOGIC II surround MUSIC mode.  
(The PRO LOGIC indicator lights up.)
- 5 **PRO LOGIC** : PRO LOGIC II surround PRO LOGIC mode.  
(The PRO LOGIC indicator lights up.)
- 6 **STEREO** : Normal stereo playback.

When you select **DOLBY DIGITAL** "DOLBY DIGITAL" will be displayed.

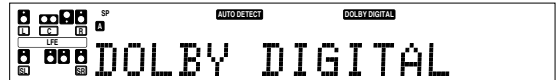

### When the DTS signal is input :

(The DTS indicator lights up.)

- 1 **DTS** : DTS surround.
- 2 **STEREO** : Normal stereo playback.

### When the analog signal or the digital signal (except for DOLBY DIGITAL or DTS signal) is input :

- 1 **PLII MOVIE** : PRO LOGIC II surround MOVIE mode.  
(The PRO LOGIC indicator lights up.)
- 2 **PLII MUSIC** : PRO LOGIC II surround MUSIC mode.  
(The PRO LOGIC indicator lights up.)
- 3 **PRO LOGIC** : PRO LOGIC II surround PRO LOGIC mode.  
(The PRO LOGIC indicator lights up.)
- 4 **CSII CINEMA** : CS 6.1 surround.  
(The CS II indicator lights up.)
- 5 **CSII MUSIC** : CS 6.1 surround.  
(The CS II indicator lights up.)
- 6 **CSII MONO** : CS 6.1 surround.  
(The CS II indicator lights up.)
- 7 **STEREO** : Normal stereo playback.  
(The STEREO indicator lights up.)

- Dolby Digital or DTS signal having more channels than the maximum number of playback channels available using the receiver's current settings is input, downmixing is performed to match the number of available channels.

### 3 DSP mode (Digital Signal Processor).

DSP can produce these effects without spoiling the sound quality of the original music or video source.

#### 1 Pressing the DSP or DSP MODE key will display the current DSP MODE status.

#### 2 Each press of the key will switch to the next status as shown below:

- 1 **ARENA** : DSP surround ARENA mode.
- 2 **JAZZ CLUB** : DSP surround JAZZ CLUB mode.
- 3 **THEATER** : DSP surround THEATER mode.
- 4 **STADIUM** : DSP surround STADIUM mode.
- 5 **DISCO** : DSP surround DISCO mode.

- The DSP mode selection is displayed for approximately 3 seconds.

### 4 Adjust the volume.

#### Notes

- Depending on the type of the signal or speaker setting, some listening modes cannot be selected.
- When playback is started, the sound may be cut or interrupted before the input source is confirmed as Dolby Digital.
- To enjoy Dolby Digital surround (as well as all the other listening modes) from a single component, be sure to use a Dolby Digital compatible source component.

## DVD 6-channel playback

Using a DVD player or the like equipped with six (5.1) output channels and the receiver, you can enjoy surround sound playback.

When you try to play a disc other than Dolby Digital such as DTS CD, no sound is produced or, noise may be heard. To avoid this situation, make sure that you connect the component to the receiver's DVD/6CH INPUT jacks through a surround processor which can decode the surround signal you want to listen to.

Connecting a DVD player which can decode the surround signal itself is also acceptable.

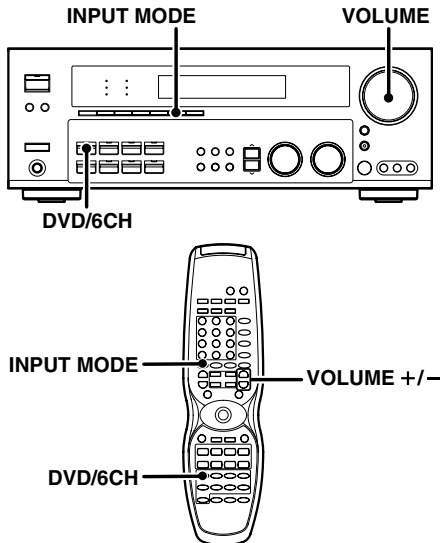

### Preparations

- Connect your DVD player to the DVD/6CH jacks of the receiver.
- Turn on all other components that will be used.
- Complete "Preparing for surround sound".

#### 1 Press "DVD/6CH" as the input source.

- If speaker system B is on when "DVD/6CH" is selected as the input source, it switches off and speaker system A turns on automatically.

#### 2 Select "6CH INPUT" by pressing the INPUT MODE key.

#### 3 Start playback of the DVD software.

#### 4 Adjust the volume.

- It is not possible to adjust the volume level or sound quality (SET UP, SOUND) of the channels separately when the receiver is in the DVD/6CH mode. Adjust the volume with the controls of the DVD player.
- For the powered subwoofer, you can adjust the volume of the subwoofer using the subwoofer's own volume control.

## Convenient functions

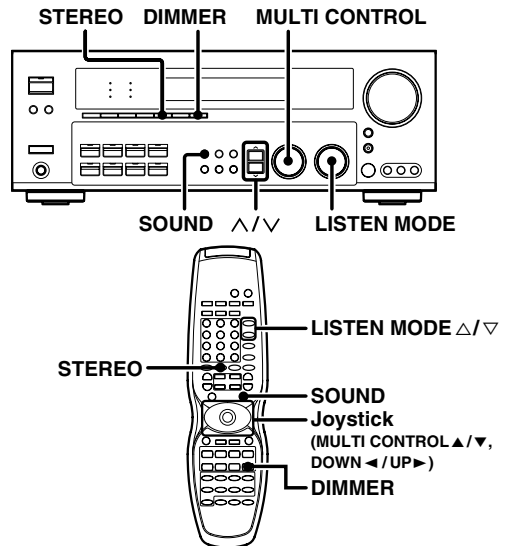

### Adjusting the sound

You can make further adjustments to the sound while listening to playback in the surround mode.

- 1 Press the SOUND key and then use to the ^/∇ keys or Joystick (◀/▶) until the desired item appears in the display.

Each time you press the ^/∇ keys or Joystick (◀/▶), the menu changes as follows:

Note that some items are not displayed in certain modes.

- 1 CNTR (Center speaker level adjustment)\*
- 2 SR (Right surround speaker level adjustment)\*
- 3 SB (Surround back speaker level adjustment)\*
- 4 SL (Left surround speaker level adjustment)\*
- 5 SUBW (Subwoofer level adjustment)\*
- 6 INPUT (Input level adjustment - analog mode only) → [21]
- 7 MIDNIGHT (Midnight mode ON/OFF - Dolby Digital mode only)
- 8 PANORAMA (Panorama mode ON/OFF)\*\*
- 9 DIMENSION (Dimension adjustment)\*\*
- 10 CENTER WIDTH (Center width adjustment)\*\*
- 11 CENTER FOCUS (Center focus adjustment)\*\*
- 12 CSII DLY (Rear speaker delay adjustment)\*\*\*
- 13 CSII GAIN (Input gain adjustment)\*\*\*
- 14 TruBass (Trubass adjustment)\*\*\*

\* The adjustment is only temporary for the current input selection. The value will return automatically to the original setup value when the power is turned on/off or when the input selection is changed.

\*\* Pro Logic II Music mode only.

\*\*\* CS II mode only.

- 2 Use the MULTI CONTROL knob or Joystick (▲/▼) to adjust the setting as desired.

- The adjustment item is displayed for approximately 8 seconds.

### Midnight mode (Dolby Digital mode only)

When watching movies at night, you might not be able to raise the volume as loud as normal. Midnight mode compresses the dynamic range of previously specified parts of the Dolby Digital sound track (like scenes with sudden increases in volume) to minimize the difference in volume between the specified and non-specified parts. This makes it easy to hear all of the sound track, even when listening at low volumes.

- 1 Press the **SOUND** key, then press the **^/∨** keys or **Joystick (◀/▶)** until **"MIDNIGHT"** appears on the display.
  - This can be selected only if CD/DVD, DVD/6CH or VIDEO 2 is selected as the source and the listen mode is set to "DOLBY DIGITAL".
- 2 Use the **MULTI CONTROL** knob or **Joystick (▲/▼)** to select the **ON** or **OFF** setting.



- The adjustment item is displayed for approximately 8 seconds.
- Some Dolby Digital software may not be compatible with the Midnight mode.

### Panorama mode (Pro Logic II Music mode only)

When listening to music, you will be able to enjoy the "wraparound" sound effect when you adjust the panorama mode.

- 1 Press the **SOUND** key, then press the **^/∨** keys or **Joystick (◀/▶)** until **"PANORAMA"** appears on the display.
- 2 Use the **MULTI CONTROL** knob or **Joystick (▲/▼)** to select **PANORAMA ON** or **OFF**.

- ① **PANORAMA ON** : PANORAMA mode is ON.
- ② **PANORAMA OFF** : PANORAMA mode is OFF.



### Dimension mode (Pro Logic II Music mode only)

When listening to music with certain recordings, you will also be able to achieve a suitable balance from all the speakers by adjusting the dimension mode.

- 1 Press the **SOUND** key, then press the **^/∨** keys or **Joystick (◀/▶)** until **"DIMENSION"** appears on the display.
- 2 Use the **MULTI CONTROL** knob or **Joystick (▲/▼)** to adjust the soundfield towards the rear or the front.

Soundfield is adjusted towards the front.

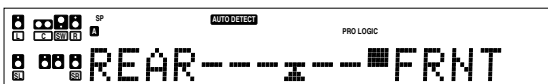

Soundfield is in neutral position.

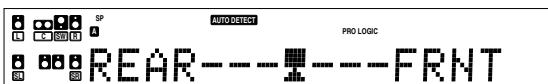

Soundfield is adjusted towards the rear.

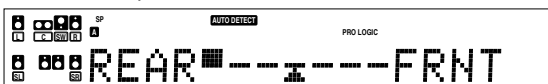

### Center Width mode (Pro Logic II Music mode only)

Center width adjustment allows you to enjoy an enhanced sound when listening to music through center image from only center speaker, or left and right speakers or various combinations adjustments.

- 1 Press the **SOUND** key, then press the **^/∨** keys or **Joystick (◀/▶)** until **"CENTER WIDTH"** appears on the display.
  - The **CENTER WIDTH** indication scrolls across the display.
  - When the center speaker is switched **OFF**, this mode will not be effective.
- 2 Use the **MULTI CONTROL** knob or **Joystick (▲/▼)** to adjust the **left-center-right** output.

Center image will be heard from center speaker only.

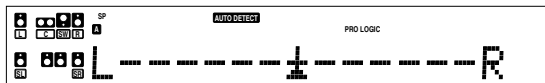

Center image will be heard from left and right speakers only.

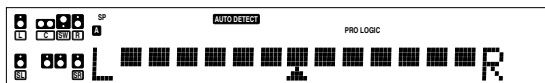

- When in other position, center image from center speaker, left and right speakers can be heard simultaneously with various combinations.

### Circle Surround II mode

When you select the circle surround II mode, you will be able to enjoy the multi surround sound from the stereo source.

Use the **LISTEN MODE** knob or **LISTEN MODE ▲/▼** keys for **CS II** selection.

### Center Focus mode (CS II mode only)

Center focus elevate level adjustment allows you to enjoy an enhanced sound when you select **CS II CINEMA/MUSIC/MONO**. It repositions the sound image to an optimal position more natural to the listener through the center image.

- 1 Press the **SOUND** key, then press the **^/∨** keys or **Joystick (◀/▶)** until **"CENTER FOCUS"** appears on the display.

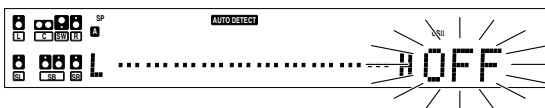

- 2 Use the **MULTI CONTROL** knob or **Joystick (▲/▼)** to adjust the **center elevation level**.

- The adjustment range is from 0 to 10.

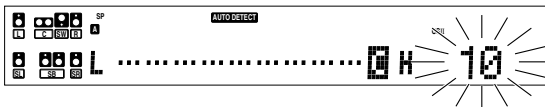

- **CENTER FOCUS** will not be available when the center speaker is **OFF**.

### CS II Rear Delay adjustment mode (CS II mode only)

CS II Rear Delay adjustment provides a better sound effect from the rear speakers.

- ❶ Press the **SOUND** key, then press the **^/∨** keys or Joystick (**◀/▶**) until "CSII DLY" appears on the display.
- ❷ Use the **MULTI CONTROL** knob or Joystick (**▲/▼**) to adjust the rear speaker.
  - The adjustment range is from 0 ms to 25 ms.

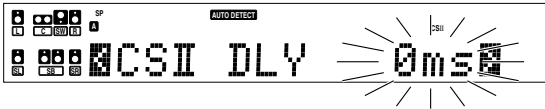

### CS II Gain adjustment mode (CS II mode only)

CS II GAIN allows user to adjust the input gain for the Circle Surround II processing.

- ❶ Press the **SOUND** key, then press the **^/∨** keys or Joystick (**◀/▶**) until "CSII GAIN" appears on the display.
- ❷ Use the **MULTI CONTROL** knob or Joystick (**▲/▼**) to adjust the input gain.
  - The adjustment range is from 0 to 18.

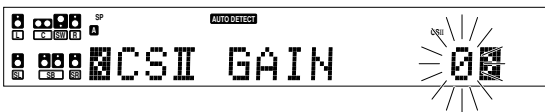

### TruBass adjustment mode (CS II mode only)

TruBass adjustment provides deep, rich bass sound to various speakers.

- ❶ Press the **SOUND** key, then press the **^/∨** keys or Joystick (**◀/▶**) until "TruBass" appears.
- ❷ Use the **MULTI CONTROL** knob or Joystick (**▲/▼**) to select the following;

- ❶ TruBass OFF
- ❷ TruBass SW
- ❸ TruBass LR
- ❹ TruBass SW + LR

• After selecting ❷, ❸ or ❹, TruBass speaker size and level adjustment selection will be available.

- ❸ For TruBass speaker selection, use the **MULTI CONTROL** knob or Joystick (**▲/▼**) to select any of the following display;

- ❶ TruBass LARGE
- ❷ TruBass MID
- ❸ TruBass SMALL

- ❹ Use the **MULTI CONTROL** knob or Joystick (**▲/▼**) to adjust the TruBass Level.

• The adjustment range is from 0 (TruBass OFF) to 10.

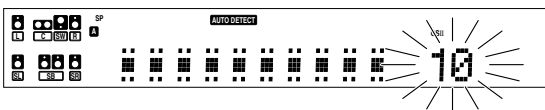

### Display dimmer adjustment

The dimmer function lets you select the brightness of the receiver's display. You might find this useful if you darken your room to watch movies or listen to music.

Each time you press the **DIMMER** key, the display's brightness changes among the three available settings. Select the brightness level you find most pleasing.

- ❶ Bright
- ❷ Medium
- ❸ Dark

### 96kHz LPCM playback

The receiver is compatible with the 96kHz LPCM playback. To play a 96kHz DVD, set the listen mode to "STEREO".

- In **FULL AUTO** input mode, the listen mode will automatically be STEREO.
- When in **DIGITAL MANUAL** input mode (listen mode is not STEREO), "FS 96kHz" will appear in the display and no sound can be heard from the speakers. Press the **LISTEN MODE** or **STEREO** key (the listen mode changes to the STEREO mode) to output sound from the speakers.



# Basic remote control operations for other components

The remote control supplied with this receiver is also capable of controlling components from a variety of manufacturers once you register the appropriate setup codes into the remote control unit.

## Low battery warning

Replace all two batteries with new ones when you notice a shortening of the distance from which the remote control will operate. In order to retain the setup codes, please change the batteries approximately within 30 seconds. If the setup codes are erased, please re-enter the codes.

## Registering setup codes for other components

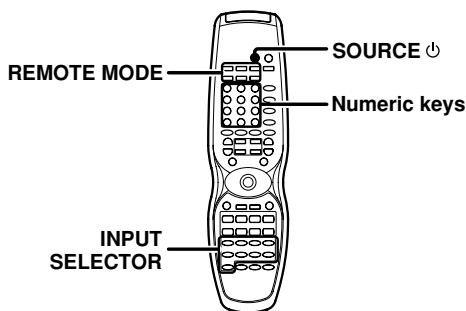

### 1 Find the setup code of the component to be registered.

- Refer to the setup code lists to find the setup code for the component to be registered. 35 - 36
- Example: To register a DVD made by KENWOOD, you would enter "805".

Input	Component	Maker	Code	Key
(DVD)	DVD player	KENWOOD	805, 808	DVD

### 2 Registering components for REMOTE MODE [(DVD, CBL, DSS/SAT, VCR, TV, OTHERS - RC-R0725/R0727) or (DVD, CD, CBL/SAT, VCR, TV, OTHERS - RC-R0726)] keys.

- For DVD, CD, CBL, DSS/SAT, CBL/SAT, VCR or TV keys;

Hold down the SOURCE key and press the numeric keys to enter the setup code.

- Example: Press "805" to register a DVD player manufactured by KENWOOD.
- If you push an invalid key, the remote control will exit the setup mode.

- The OTHERS key enables you to operate another DVD, CD, CBL, DSS/SAT, CBL/SAT, VCR or TV component.

For OTHERS key;

Hold down the OTHERS key and press the numeric keys to enter the setup code.

- Example: After you have registered the KENWOOD DVD player, press "804" to register another DVD player which is manufactured by Panasonic.
- If you push an invalid key, the remote control will exit the setup mode.

### 3 Press any of the REMOTE MODE key and then press the SOURCE key to check that the component you want to control turns on.

If the component does not react, and there is more than one setup code, enter another setup code and try again.

- If the component is already on, pressing the SOURCE key will turn it off.

### 4 Repeat steps 2 to 3 to register additional components until all components have been registered.

## Alternative REMOTE MODE key .

This operation is optional and is convenient when you link an INPUT SELECTOR key to the REMOTE MODE key. While operating one component, the INPUT SELECTOR key functions as an alternative REMOTE MODE key to select another component.

- Example: REMOTE MODE (DVD) key can be linked to the INPUT SELECTOR (VIDEO 1) key as described below;

### 1 After registering the setup code, press and hold the SOURCE key and then press the REMOTE MODE (DVD) key.

### 2 While holding down the SOURCE key, press the INPUT SELECTOR (VIDEO 1) key.

- Now the VIDEO 1 key will function as a DVD key which can be selected at the same time while operating a CD player.
- Repeat step 1 to 2 to link other INPUT SELECTOR keys.

## Note

Although each setup code is designed to work with a number of different models, certain codes may not work with some models. (Also, certain codes may only operate some of the functions available on a given model.)

## Operating other components

This operation lets you operate the registered components. KENWOOD audio components with system control turn on and off automatically with the receiver via the system control connections.

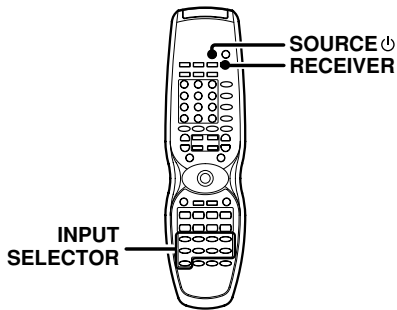

**1 Use the INPUT SELECTOR keys to select the component you desire.**

- Pressing the INPUT SELECTOR keys also changes the input selector on the receiver.
- When you operate your registered DVD player, Cable tuner, DSS/SAT receiver, VCR or TV, go to step 2.
- When you operate the CD player, Cassette deck, MD player, or Tuner with system control connection, go to step 3.

**2 Press the SOURCE  key.**

- To return to the receiver operation mode, press the RECEIVER key.

**3 Press the operation keys you desire.**



The remote control mode remains at the selected input. If you wish to operate another component, repeat step 2 or 3.

---

Note

Be sure to point the remote control at the remote sensor on the receiver when you want to operate KENWOOD components connected by system control cords. Otherwise, point the remote control at the component you want to operate.

## Setup code chart (RC-R0727) (VR-6050/KRF-V6060D)/(RC-R0725)/(KRF-V7060D)

### TV Setup codes

Maker	Setup codes
AKAI	125
BELL+HOWELL	142
CENTURION	126
CORONAD	127
DAEWOO	136, 140, 141, 145
EMERSON	130, 131, 132, 133, 146
FISHER	119
G.E.	102, 122, 129
GOLD STAR	137, 148
HITACHI	114, 115
JVC	113
KTV	138, 139
LOEWE	123, 124
MAGNAVOX	109, 147
MARANTZ	121
MITSUBISHI	121
PANASONIC	111, 112, 122, 129
PHILIPS	109, 147
PIONEER	116
PROSCAN	117
RADIOSHACK	128
RCA	102, 103, 104, 105, 106, 126
SAMSUNG	134, 135
SANYO	119
SEARS	120
SHARP	110
SONY	101
SYMPHONIC	143, 144
TOSHIBA	120
QUASAR	111, 118
ZENITH	107, 108

### CBL codes

Maker	Setup codes
GEMINI	218
G.I.	209
HAMLIN	210, 211, 234, 235
JERROLD	201, 202, 224, 225, 226, 227, 228, 229, 233
MACOM	215, 216, 217
MAGNAVOX	236
OAK	212, 213, 214
PANASONIC	221, 222, 232
PHILIPS	219, 220, 237, 238, 239, 240
PIONEER	206, 207
SAMSUNG	223
S. ATLANTA	203, 230, 231
TOCOM	208
ZENITH	204, 205

### VCR Setup codes

Maker	Setup codes
AIWA	352
AKAI	354, 355, 356
BELL+HOWELL	351
DAEWOO	349
EMERSON	334, 335, 336, 337, 338
FISHER	330, 341, 342, 343
G.E.	307, 321
GOLD STAR	323
GO_VIDEO	347, 348, 353
HITACHI	307, 308, 328, 329
JVC	324, 325, 326, 327
MAGNAVOX	311, 312, 313
MITSUBISHI	315, 316, 317, 318, 357, 358
NEC	344, 345
ORION	335
PANASONIC	309, 310
PHILIPS	313
QUASAR	309, 310, 311, 312
RCA	308
SAMSUNG	332, 339, 340
SANYO	351
SCOTT	331
SHARP	319, 320
SHINTOM	333
SONY	301, 302, 303, 304, 305, 306
SYNPHO	346
TEKNICA	346, 350
TOSHIBA	314
ZENITH	322

### DVD player Setup codes

Maker	Setup codes
HITACHI	812
JVC	801
KENWOOD	805, 808
MITSUBISHI	810
ONKYO	815, 816
PANASONIC	804
PHILIPS	807
PIONEER	803
PROSCAN	811
RCA	811
SAMSUNG	814
SONY	802
TOSHIBA	806
YAMAHA	809
ZENITH	806, 813

### DSS/SAT codes

Maker	Setup codes
EHOSTAR	903
G.I.	902
HITACHI	908
HUGHES	906
PANASONIC	905
PRIMESTAR	909
RCA	901
SONY	907
TOSHIBA	904

**Setup code chart (RC-R0726) (KRF-V6060D) (For the U.K. only)**

**TV Setup codes**

Maker	Setup codes
AKAI	408
BLAUPUNKT	401
FENNER	412
FISHER	413
GRUNDIG	402
HITACHI	414, 415
INNO-HIT	416
IRRADIO	408
JVC	417
LOEWE	429, 430
MAGNAVOX	406
MIVER	401
NOKIA	403
NORDMENDE	404, 405
OKANO	416
ORION	418
PANASONIC	419, 420
PHILIPS	406
SABA	404, 407
SAMSUNG	421
SANYO	413
SCHNEIDER	408
SHARP	422
SONY	423, 424, 425, 426, 427
TELEFUNKEN	407, 409, 410
THOMSON	411
TOSHIBA	428

**VCR Setup codes**

Maker	Setup codes
AIWA	513
BELL+HOWELL	514
BLAUPUNKT	501
CGM	514, 515
DIGITAL	515
FISHER	514
G.E.	516
GRUNDIG	502
HITACHI	517, 518
JVC	519
LOEWE	503, 504
MAGNAVOX	501, 515
MITSUBISHI	520, 521, 522, 523
NOKIA	505
NORDMENDE	506, 507, 508
PANASONIC	524
PHILIPS	509
PHONOLA	515
SABA	510
SAMSUNG	525, 526
SANYO	514
SHARP	527, 528
SIEMENS	502
SONY	529, 530, 531
TELEFUNKEN	511, 512
TOSHIBA	532

**CBL/SAT codes**

Maker	Setup codes
AMSTRAD	601, 602, 603, 604, 633
CANAL+	622
D-BOX	626
ECHOSTAR	619, 620, 621, 623
FORCE	630
GALAXIS	629
GRUNDIG	605, 606
HIRSCHMANN	639
ITT	609
JERROLD	616
JVC	614
JVC/BT	613
KATHREIN	611, 612, 636
MASCOM	634
NOKIA	628, 635
PACE	608, 627
PANASONIC	615
PHILIPS	607, 625
SELECTOR	631
SKYMASTER	610, 638
THOMSON	637
TPS/SAGEM	624
TRIAx	632
VIDEOWAY	617, 618

**DVD player Setup codes**

Maker	Setup codes
JVC	801
KENWOOD	805, 808
PANASONIC	804
PHILIPS	807
PIONEER	803
SONY	802
TOSHIBA	806

**CD player Setup codes**

Maker	Setup codes
DENON	702
ONKYO	704
PHILIPS	705
PIONEER	706
SONY	701
TEAC	703
YAMAHA	707

## CASSETTE deck, CD player & MD recorder operations

You can perform these basic operations using the keys described below when connected to KENWOOD cassette deck, CD player or MD recorder equipped with system control operations. - 17

### Cassette deck operations keys

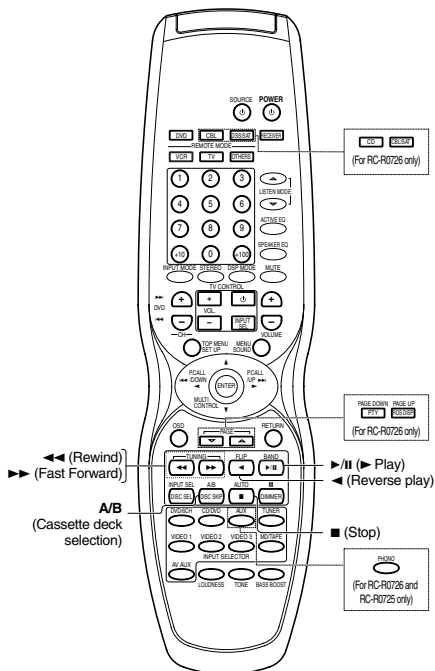

### CD player operation keys

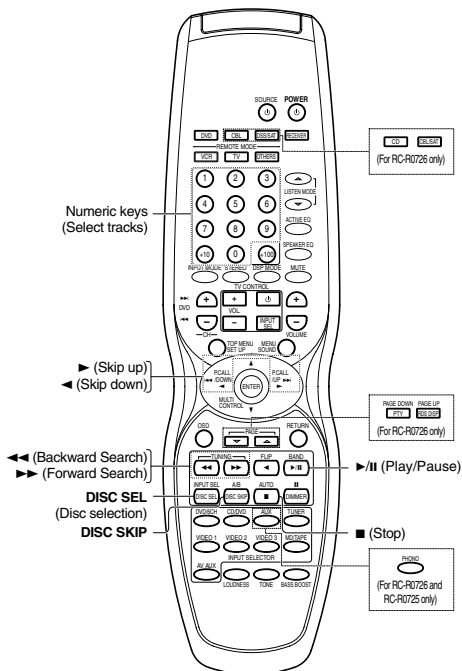

### MD recorder operation keys

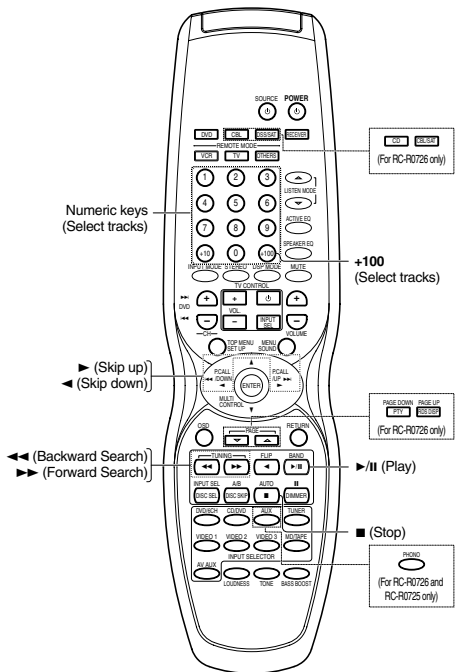

## Other components' operations

Refer to the following for the type of remote control operations available for each component.

- ① Select the input source.
- ② Press the keys corresponding to the operations you desire. Refer to the following sections for details.

- When pressing keys in succession, press each key firmly and be sure to wait at least 1 second before pressing the next key.
- Numeric keys function the same as the numeric keys on the original remote.

These keys can be used to perform the basic operations of KENWOOD and other manufacturers' components which the setup code for each component had been entered beforehand. → [35] → [36]

### TV operation keys

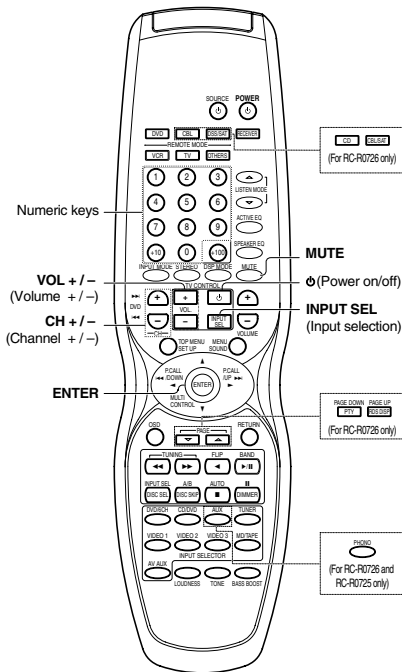

### VCR operation keys

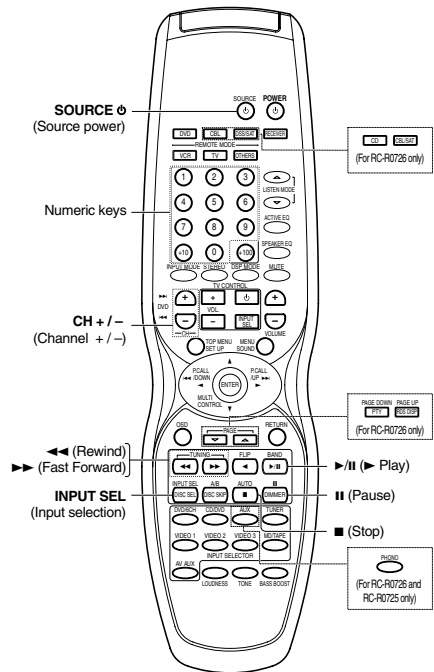

DSS/SAT (or CBL/SAT) receiver operation keys

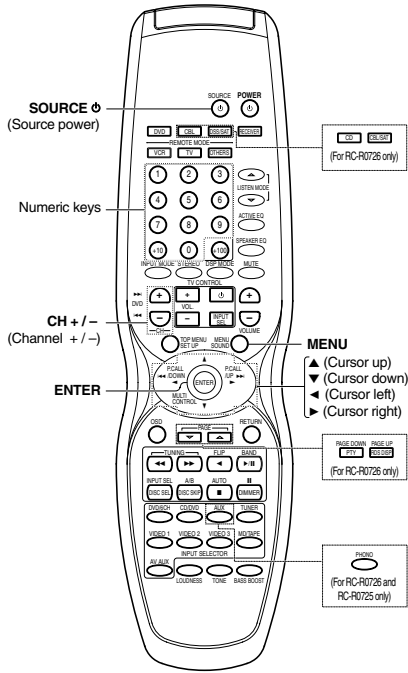

Cable tuner operation keys

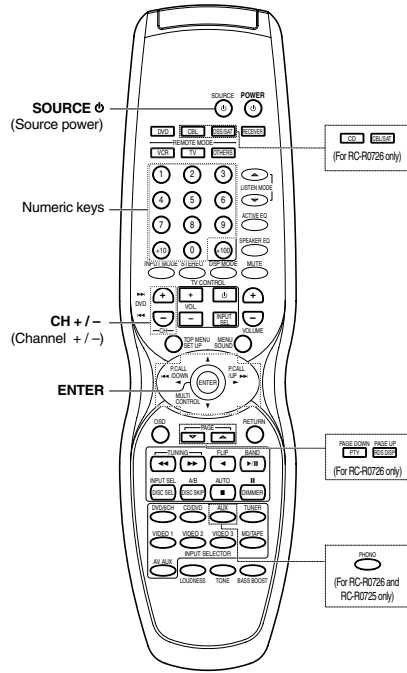

DVD player operation keys

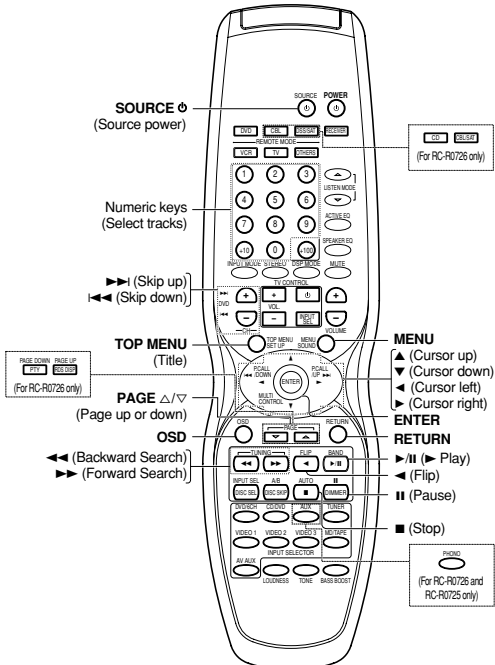

# In case of difficulty

## Resetting the Microcomputer

The microcomputer may malfunction (unit cannot be operated, or shows an erroneous display) if the power cord is unplugged while the power is ON, or due to some other external factor. If this happens, execute the following procedure to reset the microcomputer and return the unit to its normal operating condition.

- Please note that resetting the microcomputer will clear the contents of the memory and returns the unit to the state it was in when it left the factory.









## For the U.S.A. and Canada

Unplug the power cord from the wall outlet, then plug it back in while holding down the POWER ON/STANDBY  key.



## For other countries

With the power cord plugged in, turn the POWER ON/OFF key OFF. Then, while holding down the ON/STANDBY  key, press POWER ON/OFF.

## Amplifier

Symptom	Cause	Remedy
No sound from the speakers.	<ul style="list-style-type: none"> <li>• The speaker cords are disconnected.</li> <li>• VOLUME is set to the minimum position.</li> <li>• MUTE is ON.</li> <li>• The SPEAKERS switches are set to OFF.</li> </ul>	<ul style="list-style-type: none"> <li>• Connect them properly referring to "Connecting the speakers" <span style="float: right;">-  14</span></li> <li>• Adjust the volume to a proper level.</li> <li>• Turn OFF the MUTE. <span style="float: right;">-  22</span></li> <li>• Set the SPEAKERS switches to ON. <span style="float: right;">-  21</span></li> </ul>
The standby indicator blinks and sound is not output.	<ul style="list-style-type: none"> <li>• Speaker cords are short-circuited.</li> </ul>	<ul style="list-style-type: none"> <li>• Turn the power off, eliminate the short-circuiting, then turn on the power again.</li> </ul>
Sound is not output from one of the speakers.	<ul style="list-style-type: none"> <li>• The speaker cord is disconnected.</li> </ul>	<ul style="list-style-type: none"> <li>• Connect it properly referring to "Connecting the speakers". <span style="float: right;">-  14</span></li> </ul>
Sound is not output from the surround speakers and / or the center speaker, or their sound is very small.	<ul style="list-style-type: none"> <li>• The surround speaker cords and/or the center speaker cord is disconnected.</li> <li>• A surround mode has not been engaged.</li> <li>• The surround and/or center volume controls are set to the minimum level.</li> </ul>	<ul style="list-style-type: none"> <li>• Connect it properly referring to "Connecting the speakers". <span style="float: right;">-  14</span></li> <li>• Select a surround mode.</li> <li>• Adjust the speaker levels using the test tone. <span style="float: right;">-  19</span></li> </ul>
A humming noise is generated when the PHONO input selector is selected.	<ul style="list-style-type: none"> <li>• The audio cord from the record player is not connected to the PHONO jacks.</li> <li>• The record player is not grounded.</li> </ul>	<ul style="list-style-type: none"> <li>• Insert the audio cord plugs securely into the PHONO jacks.</li> <li>• Connect the grounding wire to the GND terminal on the rear panel.</li> </ul>
When playing a Dolby Digital source signal using a DVD player, the sound is cut off soon after it starts.	<ul style="list-style-type: none"> <li>• There are many possible causes for this problem, depending on the type of DVD player used.</li> </ul>	<ul style="list-style-type: none"> <li>• Set the input mode to digital manual before starting playback of the Dolby Digital source. <span style="float: right;">-  9</span></li> </ul>
No sound is produced during playback from a DVD player.	<ul style="list-style-type: none"> <li>• The input mode is set to digital manual.</li> </ul>	<ul style="list-style-type: none"> <li>• Press the INPUT MODE key to select to full auto mode. <span style="float: right;">-  9</span></li> </ul>
A video source cannot be recorded normally.	<ul style="list-style-type: none"> <li>• The software is copy-guarded.</li> </ul>	<ul style="list-style-type: none"> <li>• Copy-guarded video software cannot be recorded.</li> </ul>

## Tuner

Symptom	Cause	Remedy
Radio stations cannot be received.	<ul style="list-style-type: none"> <li>• No antenna is connected.</li> <li>• The broadcast band is not set properly.</li> <li>• The frequency of the desired station is not tuned.</li> </ul>	<ul style="list-style-type: none"> <li>• Connect an antenna. <span style="float: right;">-  16</span></li> <li>• Set the broadcast band properly.</li> <li>• Tune the frequency of the desired station. <span style="float: right;">-  24</span></li> </ul>
Interference.	<ul style="list-style-type: none"> <li>• Noise due to ignition noise from an automobile.</li> <li>• Noise due to interference from an electric appliance.</li> <li>• Noise due to a nearby TV set.</li> </ul>	<ul style="list-style-type: none"> <li>• Install the outdoor antenna away from the road.</li> <li>• Turn off the power to the appliance.</li> <li>• Install the receiver farther away from the TV.</li> </ul>
A station which was preset cannot be received by pressing the corresponding numeric key.	<ul style="list-style-type: none"> <li>• The preset station belongs to a frequency that cannot be received.</li> <li>• The preset memory was cleared because the power cord had been unplugged for a long period of time.</li> </ul>	<ul style="list-style-type: none"> <li>• Preset a station with a receivable frequency.</li> <li>• Preset the station again.</li> </ul>



**Remote control unit**

Symptom	Cause	Remedy
<p><b>Certain inputs cannot be selected using the remote control.</b></p>	<ul style="list-style-type: none"> <li>• No setup codes registered for the respective input(s).</li> </ul>	<ul style="list-style-type: none"> <li>• Register a setup code at the respective input(s). → [35] → [36]</li> </ul>
<p><b>Remote control operation is not possible.</b></p>	<ul style="list-style-type: none"> <li>• The remote control is set to a different operation mode.</li> <li>• Batteries are exhausted.</li> <li>• The remote control unit is too far away from the main system, controlling angle is too large, or there is an obstacle between the receiver and the remote.</li> <li>• The audio cords and system control cords are not connected properly.</li> <li>• No software is loaded in the source component.</li> <li>• An attempt is made to play a tape which is being recorded in the cassette deck.</li> <li>• The remote control has not been set to the operation mode for the component you wish to control.</li> </ul>	<ul style="list-style-type: none"> <li>• Press the source select keys or <b>SOURCE</b> ⏏ keys to select the appropriate operation mode.</li> <li>• Replace with new batteries.</li> <li>• Operate the remote control unit within the controllable range.</li> <li>• Connect properly referring to “Setting up the system”.</li> <li>• Place software in the source component you want to play.</li> <li>• Wait until recording has completed.</li> <li>• Press the source select keys or <b>SOURCE</b> ⏏ key to activate the operation mode for the component you want to control before operation. → [34]</li> </ul>

# Specifications

⚠ Caution : Read this page carefully to ensure safe operation.

## For the U.S.A and Canada

### AUDIO section (VR-6050)

Rated power output during STEREO operation

100 watts per channel minimum RMS, both channels driven, at 8 Ω from 20 Hz to 20 kHz with no more than 0.09% total harmonic distortion. (FTC)

Effective power output during SURROUND operation

FRONT (20 ~ 20 kHz, 0.09 % T.H.D. at 8 Ω one channel driven) ..... 100 W + 100 W  
CENTER (20 ~ 20 kHz, 0.09 % T.H.D. at 8 Ω one channel driven) ..... 100 W  
SURROUND (20 ~ 20 kHz, 0.7 % T.H.D. at 8 Ω one channel driven) ..... 100 W + 100 W

Total harmonic distortion ..... 0.009 % (1 kHz, 50 W, 8 Ω)  
Frequency response

Line (CD/DVD, TAPE, VIDEO 1, VIDEO 2, VIDEO 3, DVD/6CH) ..... 10 Hz ~ 100 kHz, +0 dB ~ -3.0 dB

Signal to noise ratio (IHF'66)

Line (CD/DVD, TAPE, VIDEO 1, VIDEO 2, VIDEO 3, DVD/6CH) ..... 95 dB

Loudness control

VOLUME at -30 dB level ..... +6 dB (100 Hz)

Input sensitivity / impedance

Line (CD/DVD, TAPE, VIDEO 1, VIDEO 2, VIDEO 3, DVD/6CH) ..... 500 mV / 47 kΩ

Output level / impedance

TAPE REC ..... 500 mV / 1 kΩ  
PRE OUT (SURROUND BACK CHANNEL) ..... 2.5 V / 1 kΩ  
PRE OUT (SUBWOOFER) ..... 2.5 V / 1 kΩ

Tone control

BASS ..... ±10 dB (at 100 Hz)  
TREBLE ..... ±10 dB (at 10 kHz)

## For other countries (except for the U.K.)

### AUDIO section (KRF-V7060D/V6060D)

Effective power output during STEREO operation

1 kHz, 10 %, 8 Ω ..... 110 W + 110 W

Rated power output during STEREO operation

100 watts per channel minimum RMS, both channels driven, at 8 Ω from 20 Hz to 20 kHz with no more than 0.09% total harmonic distortion. (FTC)

Effective power output during SURROUND operation

FRONT (1 kHz, 10 % T.H.D. at 8 Ω one channel driven) ..... 110 W + 110 W  
CENTER (1kHz, 10 % T.H.D. at 8 Ω one channel driven) ..... 110 W  
SURROUND (1 kHz, 10 % T.H.D. at 8 Ω one channel driven) ..... 110 W + 110 W

Total harmonic distortion ..... 0.009% (1 kHz, 50 W, 8 Ω)  
Frequency response

Line (CD/DVD, TAPE, VIDEO 1, VIDEO 2, VIDEO 3, DVD/6CH) ..... 10 Hz ~ 100 kHz, +0 dB ~ -3.0 dB

PHONO 'RIAA' response (KRF-V7060D)

..... 40 Hz ~ 20 kHz, 1.5 dB ~ -3.0 dB

Maximum input level

PHONO (MM) (KRF-V7060D) ..... 45 mV, 1 % T.H.D. at 1 kHz

Signal to noise ratio (IHF'66)

PHONO (MM) (KRF-V7060D) ..... 75 dB  
Line (CD/DVD, TAPE, VIDEO 1, VIDEO 2, VIDEO 3, DVD/6CH) ..... 95 dB

Loudness control

VOLUME at -30 dB level ..... +6 dB (100 Hz)

Input sensitivity / impedance

PHONO (MM) (KRF-V7060D) ..... 6.0 mV / 47 kΩ  
Line (CD/DVD, TAPE, VIDEO 1, VIDEO 2, VIDEO 3, DVD/6CH) ..... 500 mV / 47 kΩ

Output level / impedance

TAPE REC ..... 500 mV / 1 kΩ  
PRE OUT (SURROUND BACK CHANNEL) ..... 2.5 V / 1 kΩ  
PRE OUT (SUBWOOFER) ..... 2.5 V / 1 kΩ

Tone control

BASS ..... ±10 dB (at 100 Hz)  
TREBLE ..... ±10 dB (at 10 kHz)

### DIGITAL AUDIO section

Sampling frequency ..... 32 kHz, 44.1 kHz, 48 kHz, 96 kHz  
Input level / impedance / wave length

Optical ..... (-15 dBm ~ -24 dBm), 660 nm ±30 nm  
Coaxial ..... 0.5 Vp-p / 75 Ω

### VIDEO section

VIDEO inputs / outputs

VIDEO (composite) ..... 1 Vp-p / 75 Ω

S VIDEO inputs / outputs

S VIDEO (luminance signal) ..... 1 Vp-p / 75 Ω  
S VIDEO (chrominance signal) ..... 0.286 Vp-p / 75 Ω

### FM tuner section

Tuning frequency range ..... 87.5 MHz ~ 108.0 MHz  
Usable sensitivity (MONO)

VR-6050 ..... 1.3 μV (75 Ω) / 13.2 dBf (75 kHz dev, SINAD 30 dB)  
KRF-V7060D/V6060D ..... 1.6 μV (75 Ω) / 15.2 dBf (75 kHz dev, SINAD 30 dB)

50 dB quieting sensitivity

STEREO ..... 28 μV (75 Ω) / 40.2 dBf

Total harmonic distortion

MONO (1 kHz, 75 kHz dev) ..... 0.5% (65 dBf input)  
STEREO (1 kHz, 67.5 + 6.75 kHz dev) ..... 0.7% (65 dBf input)

Signal to noise ratio

MONO (1 kHz, 75 kHz dev) ..... 75 dB (65 dBf input)  
STEREO (1 kHz, 67.5 + 6.75 kHz dev) ..... 68 dB (65 dBf input)

Stereo separation (1 kHz)

..... 40 dB

Selectivity (±400 kHz) (VR-6050) ..... 70 dB

(KRF-V7060D/V6060D) ..... 50 dB

Frequency response (30 Hz ~ 15kHz) ..... +0.5 dB, -3.0 dB

### AM tuner section

Tuning frequency range

10 kHz step ..... 530 kHz ~ 1,700 kHz (VR-6050)  
10 kHz step ..... 530 kHz ~ 1,610 kHz (KRF-V7060D/V6060D)  
9 kHz step ..... 531 kHz ~ 1,602 kHz (KRF-V7060D/V6060D)

Usable sensitivity (30% mod, S/N 20 dB)

..... 16 μV / (600 μV/m)

Signal to noise ratio (30% mod, 400 Hz)

..... 50 dB (60 dBμ VEMF input)

### GENERAL

Power consumption VR-6050 ..... 3 A  
KRF-V7060D/V6060D ..... 300 W

AC outlet

SWITCHED VR-6050 ..... (total 150 W, 1.25 A max.)  
KRF-V7060D/V6060D ..... (total 90 W max.)

Dimensions ..... W : 440 mm (17-5/16")  
H : 159 mm (6-1/4")  
D : 392 mm (15-7/16")

Weight (Net)

VR-6050 ..... 9.4 kg (20.7 lb)  
KRF-V7060D/V6060D ..... 10.0 kg (22.0 lb)

## Specifications

### For the U.K. only

#### AUDIO section (KRF-V6060D)

Rated power output during STEREO operation DIN/IEC (63 Hz ~ 12.5 kHz, 0.09 % T.H.D. at 6 $\Omega$ )	100 W + 100 W
Effective power output during SURROUND operation	
FRONT (63 Hz ~ 12.5 kHz, 0.09 % T.H.D. at 6 $\Omega$ one channel driven)	100 W + 100 W
CENTER (63 Hz ~ 12.5 kHz, 0.09 % T.H.D. at 6 $\Omega$ one channel driven)	100 W
SURROUND (63 Hz ~ 12.5 kHz, 0.7 % T.H.D. at 6 $\Omega$ one channel driven)	100 W + 100 W
Total harmonic distortion	0.009 % (1 kHz, 50 W, 6 $\Omega$ )
Frequency response	
Line (CD/DVD, TAPE, VIDEO 1, VIDEO 2, VIDEO 3, DVD/6CH)	10 Hz ~ 100 kHz, +0 dB ~ -3.0 dB
PHONO 'RIAA' response	40 Hz ~ 20 kHz, +1.5 dB ~ -3.0 dB
Maximum input level	
PHONO (MM)	45 mV, 1 % T.H.D. at 1 kHz
Signal to noise ratio (IHF'66)	
PHONO (MM)	75 dB
Line (CD/DVD, TAPE, VIDEO 1, VIDEO 2, VIDEO 3, DVD/6CH)	95 dB
Loudness control	
VOLUME at -30 dB level	+6 dB (100 Hz)
Input sensitivity / impedance	
PHONO (MM)	6.0 mV / 47 k $\Omega$
Line (CD/DVD, TAPE, VIDEO 1, VIDEO 2, VIDEO 3, DVD/6CH)	500 mV / 47 k $\Omega$
Output level / impedance	
TAPE REC	500 mV / 1 k $\Omega$
PRE OUT (SURROUND BACK CHANNEL)	2.5 V / 1 k $\Omega$
PRE OUT (SUBWOOFER)	2.5 V / 1 k $\Omega$
Tone control	
BASS	$\pm 10$ dB (at 100 Hz)
TREBLE	$\pm 10$ dB (at 10 kHz)

#### DIGITAL AUDIO section

Sampling frequency	32 kHz, 44.1 kHz, 48 kHz, 96 kHz
Input level / impedance / wave length	
Optical	(-15 dBm ~ -24 dBm), 660 nm $\pm 30$ nm
Coaxial	0.5 Vp-p / 75 $\Omega$

#### VIDEO section

VIDEO inputs / outputs	
VIDEO (composite)	1 Vp-p / 75 $\Omega$
S VIDEO inputs / outputs	
S VIDEO (luminance signal)	1 Vp-p / 75 $\Omega$
S VIDEO (chrominance signal)	0.286 Vp-p / 75 $\Omega$

#### FM tuner section

Tuning frequency range	87.5 MHz ~ 108 MHz
Usable sensitivity	
MONO	1.3 $\mu$ V (75 $\Omega$ ) / 13.2 dBf (40 kHz dev, S/N 26 dB)
STEREO	45 $\mu$ V (75 $\Omega$ ) / 42.1 dBf (40 + 6 kHz dev, S/N 46 dB)
Total harmonic distortion	
MONO (1 kHz, 40 kHz dev)	0.2% (65.2 dBf input)
STEREO (1 kHz, 40 + 6 kHz dev)	0.8% (65.2 dBf input)
Signal to noise ratio (DIN weighted at 1 kHz)	
MONO	65 dB (65.2 dBf input)
STEREO	60 dB (65.2 dBf input)
Stereo separation (1 kHz)	36 dB
Selectivity ( $\pm 300$ kHz)	64 dB
Frequency response (30 Hz ~ 15kHz)	+0.5 dB, -3.0 dB

#### MW tuner section

Tuning frequency range	531 kHz ~ 1,602 kHz
Usable sensitivity (30% mod, S/N 20 dB)	16 $\mu$ V / (600 $\mu$ V/m)
Signal to noise ratio (400 Hz, 30% mod)	
	50 dB (60 dB $\mu$ VEMF input)

#### GENERAL

Power consumption	330 W
AC outlet	
SWITCHED	(total 90 W max.)
Dimensions	W : 440 mm (17-5/16")
	H : 159 mm (6-1/4")
	D : 392 mm (15-7/16")
Weight (Net)	9.8 kg (21.6 lb)

#### Notes

1. KENWOOD follows a policy of continuous advancements in development. For this reason specifications may be changed without notice.
2. The full performance may not be exhibited in an extremely cold location (under a water-freezing temperature).

---

# KENWOOD

***For your records***

Record the serial number, found on the back of the unit, in the spaces designated on the warranty card, and in the space provided below. Refer to the model and serial numbers whenever you call upon your dealer for information or service on this product.

Model \_\_\_\_\_ Serial Number \_\_\_\_\_